

Rider's Manual

K 1200 Rsport



BMW Motorrad



The Ultimate Riding
Machine

Motorcycle data/dealership details

Motorcycle data

Model

Vehicle identification number

Colour code

Date of first registration

Registration number

Dealership details

Person to contact in Service department

Ms/Mr

Phone number

Dealership address/phone number
(company stamp)

Welcome to BMW

We congratulate you on your choice of a motorcycle from BMW and welcome you to the community of BMW riders. Familiarise yourself with your new motorcycle so that you can ride it safely and confidently in all traffic situations. Please read this Rider's Manual carefully before starting to use your new BMW motorcycle. It contains important information on how to operate the controls and how to make the best possible use of all your BMW's technical features. In addition, it contains information on maintenance and care to help you maintain your motorcycle's reliability and safety, as well as its value. If you have questions concerning your motorcycle, your

authorised BMW Motorrad dealer will gladly provide advice and assistance.

We hope that you will enjoy riding your BMW and that all your journeys will be pleasant and safe.

BMW Motorrad.

Table of Contents

You can also consult the index at the end of this Rider's Manual if you want to find a particular topic or item of information.

1 General instructions ...	5	3 Status indicators	21	On-board computer ^{OE} ...	46
Overview	6	Multifunction display	22	Emergency off switch (kill switch)	50
Abbreviations and symbols	6	Warning and telltale lights	22	Grip heating ^{OE}	50
Equipment	7	ABS warning light ^{OE}	22	Clutch	51
Technical data	7	Function indicators	22	Brakes	51
Currency	7	Warnings, general	23	Lights	52
2 General views	9	Warnings issued by the tyre pressure monitoring system (RDC) ^{OE}	31	Headlight	53
General view, left side ...	11	ABS warnings ^{OE}	35	Turn indicators	54
General view, right side	13	4 Operation	39	Seat	55
Underneath the seat	15	Ignition switch and steering lock	40	Helmet holder	57
Handlebar fitting, left	16	Electronic immobiliser (EWS)	41	Luggage loops	57
Handlebar fitting, right ...	17	Hazard warning flashers	42	Mirrors	58
Instrument cluster	18	Odometer and tripmeters	43	Spring preload	59
Headlight	19	Clock	44	Shock absorbers	60
		Tyre pressure monitoring RDC ^{OE}	46	Electronic Suspension Adjustment ESA ^{OE}	61
				Tyres	62
				5 Riding	65
				Safety instructions	66
				Checklist	68
				Starting	68
				Running in	70

Parking your motorcycle	71	Rear-wheel stand	107	Running gear	137
Refuelling	73	Bulbs	108	Brakes	138
Tyre pressure monitoring RDC ^{OE}	74	Jump starting	116	Wheels and tyres	138
Brake system, general ...	75	Battery	117	Electrics	139
Brake system with BMW Motorrad ABS ^{OE}	76	8 Care	123	Frame	141
6 Accessories	81	Care products	124	Dimensions	141
General instructions	82	Washing motorcycle ...	124	Weights	142
Power socket	82	Cleaning easily damaged components	125	10 Service	143
Luggage	83	Paint care	126	BMW Motorrad service	144
Case ^{OA}	83	Protective wax coating	126	BMW Motorrad service quality	144
7 Maintenance	87	Laying up the motorcycle	126	BMW Motorrad Service Card: on-the-spot breakdown assistance	145
General instructions	88	Restoring motorcycle to use	127	BMW Motorrad service network	145
Toolkit	88	9 Technical data	129	Maintenance work	145
Engine oil	89	Troubleshooting chart	130	Maintenance schedules	146
Brake system, general ...	91	Threaded fasteners	131	Confirmation of maintenance work	147
Brake pads	92	Engine	133	Confirmation of service	152
Brake fluid	94	Performance figures ...	135		
Clutch	96	Clutch	135		
Tyres	97	Transmission	135		
Rims	97	Rear-wheel drive	136		
Wheels	97				
Front-wheel stand	105				

General instructions

Overview	6
Abbreviations and symbols	6
Equipment	7
Technical data	7
Currency	7

Overview

Chapter 2 of this Rider's Manual will provide you with an initial overview of your motorcycle. All maintenance and servicing work on the motorcycle is documented in Chapter 10. This record of the maintenance work you have had performed on your motorcycle is a precondition for generous treatment of goodwill claims.

When the time comes to sell your BMW, please remember to hand over this Rider's Manual; it is an important part of the motorcycle.

Abbreviations and symbols



Indicates warnings that you must comply with for reasons of your safety and the safety of others, and to pro-

tect your motorcycle against damage.



Specific instructions on how to operate, control, adjust or look after items of equipment on the motorcycle.



Indicates the end of an item of information.



Instruction.



Result of an activity.



Reference to a page with more detailed information.



Indicates the end of a passage relating to specific accessories or items of equipment.



Tightening torque.



Item of technical data.



Optional extra
Your motorcycle was assembled complete with all the BMW optional extras you ordered.



Optional accessory
You can obtain optional accessories through your authorised BMW Motorrad dealer; optional accessories have to be retrofitted to the motorcycle.



Electronic immobiliser (Elektronische Wegfahrsicherung).

ESA Electronic Suspension Adjustment
Electronic Suspension Adjustment.

DWA Anti-theft alarm (Diebstahlwarnanlage)

ABS Anti-lock brake system

RDC Tyre pressure control (ReifenDruck-Control)

Equipment

When you ordered your BMW motorcycle, you chose various items of custom equipment. This Rider's Manual describes optional extras (OE) offered by BMW and selected optional accessories (OA). This explains why the manual may also contain descriptions of equipment which you have not ordered. Please note, too, that your motorcycle might

not be exactly as illustrated in this manual on account of country-specific differences. If your BMW was supplied with equipment not described in this Rider's Manual, you will find these features described in separate manuals.

Technical data

All dimensions, weights and power ratings stated in the Rider's Manual are quoted to the standards and comply with the tolerance requirements of the Deutsche Institut für Normung e. V. (DIN). Versions for individual countries may differ.

Currency

The high safety and quality standards of BMW motorcycles are maintained by constant development work on designs, equipment and ac-

cessories. Because of this, your motorcycle may differ from the information supplied in the Rider's Manual. Nor can errors and omissions be entirely ruled out. We hope you will appreciate that no claims can be entertained on the basis of the data, illustrations or descriptions in this manual.

General views

General view, left side	11
General view, right side	13
Underneath the seat	15
Handlebar fitting, left	16
Handlebar fitting, right	17
Instrument cluster	18
Headlight	19

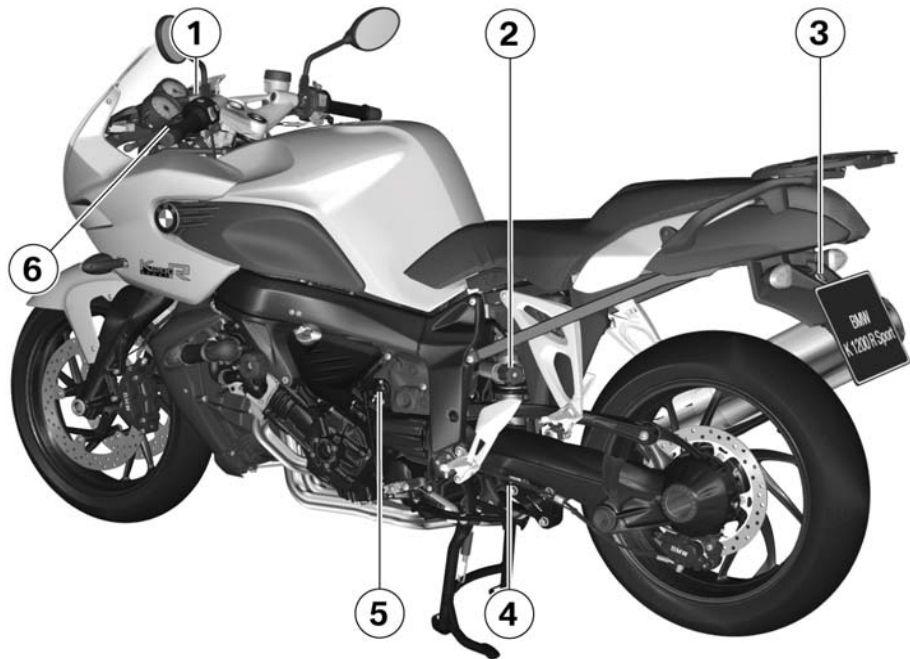

General view, left side

- 1 Clutch-fluid reservoir
(➡ 96)
- 2 Adjuster, spring preload,
rear (➡ 59)
- 3 Seat lock, beneath rear
light (➡ 55)
- 4 Adjuster, rear shock ab-
sorber (➡ 60)
- 5 Power socket (➡ 82)
- 6 Adjuster, beam throw
(➡ 54)

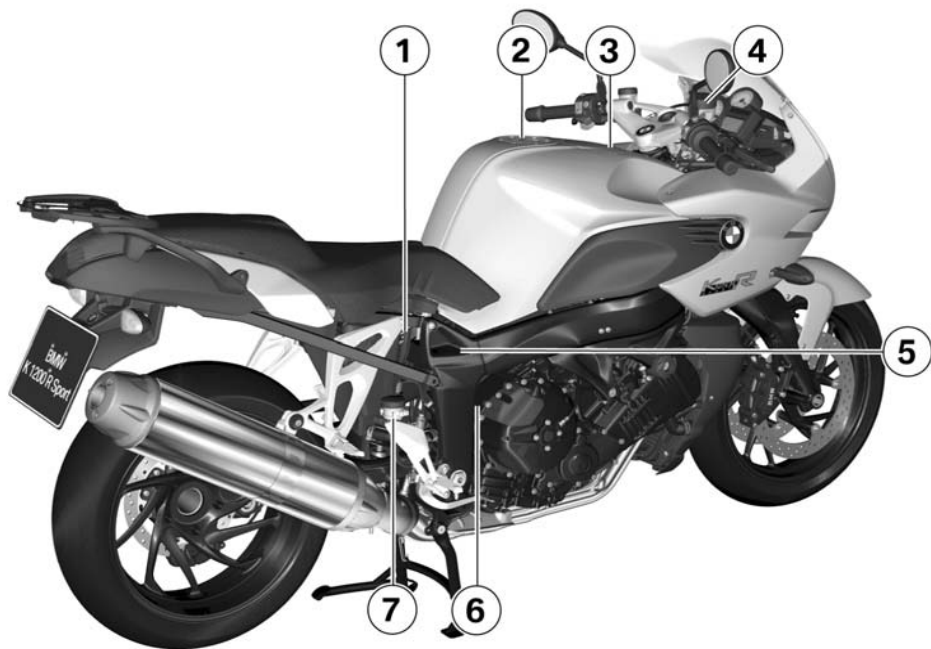

General view, right side

- 1 Indicator for engine oil level (➡ 89)
- 2 Filler neck, fuel (➡ 73)
- 3 Battery compartment (➡ 120)
- 4 Brake-fluid reservoir, front (➡ 94)
- 5 Type plate
- 6 Vehicle identification number
- 7 Brake-fluid reservoir, rear (➡ 95)

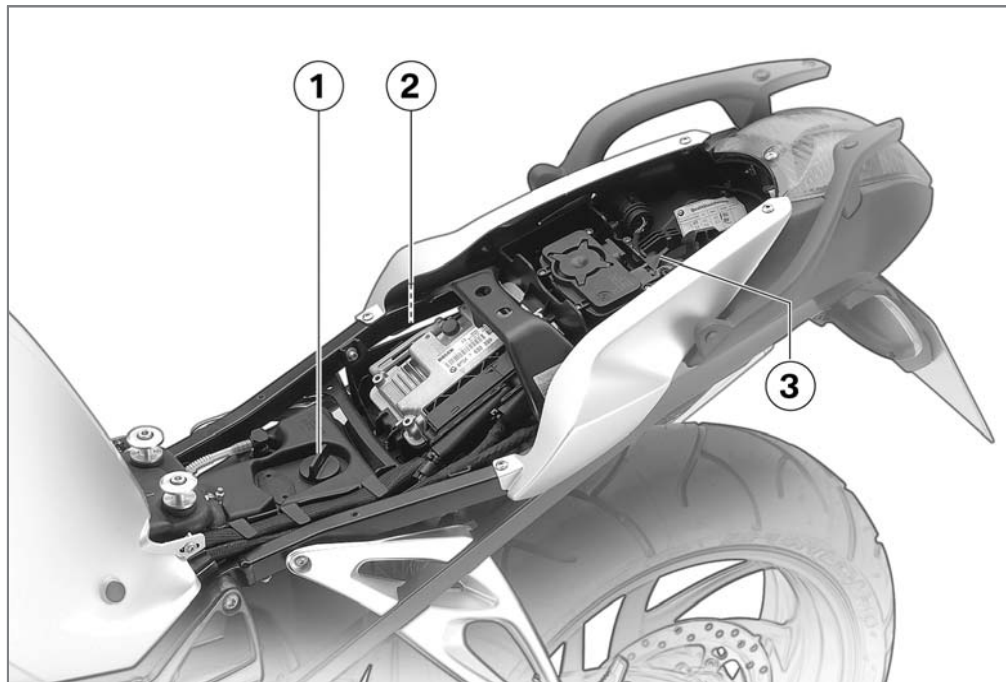

Underneath the seat

- 1 Filler neck, engine oil
(➡ 90)
- 2 Toolkit (➡ 88)
- 3 Helmet holder (➡ 57)

Handlebar fitting, left

- 1 INFO button for odometer (➔ 43), INFO button for on-board computer^{OE} (➔ 46)
- 2 Pushbutton, ESA^{OE} (➔ 61)
- 3 Pushbutton, horn
- 4 Pushbutton, left flashing turn indicators (➔ 54), Pushbutton, hazard warning flashers (➔ 42)
- 5 Switch, high-beam headlight and headlight flasher (➔ 52)



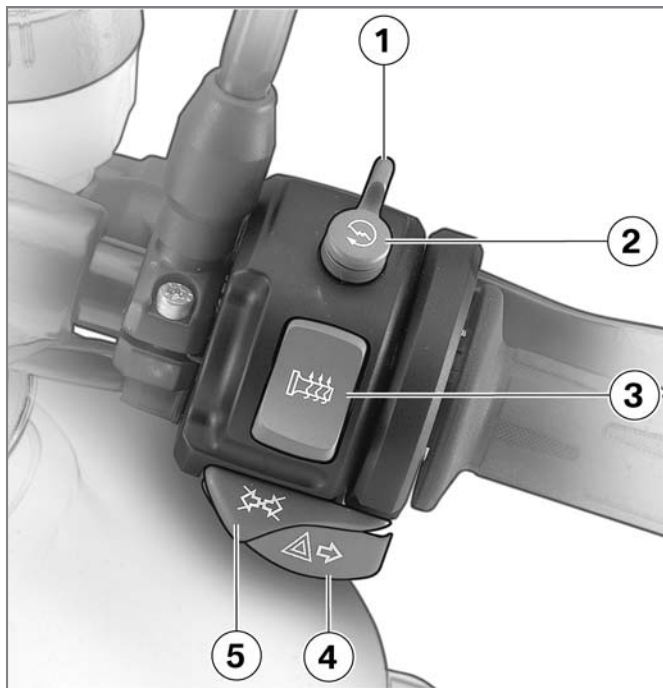

Handlebar fitting, right

- 1 Emergency off switch (kill switch) (➔ 50)
- 2 Pushbutton, starter (➔ 68)
- 3 Grip heating switch^{OE} (➔ 50)
- 4 Pushbutton, right flashing turn indicators (➔ 54), Pushbutton, hazard warning flashers (➔ 42)
- 5 Cancel button, flashing turn indicators (➔ 55), Pushbutton, cancel hazard warning flashers (➔ 43)

Instrument cluster

- 1 Speedometer
- 2 Rev. counter
- 3 Warning and telltale lights (⇒ 22)
- 4 Multifunction display (⇒ 22)
- 5 Telltale light, anti-theft alarm (OE) and sensor for instrument lighting
- 6 Control, odometer (⇒ 43)

▶ The instrument-cluster lighting has automatic day and night switchover. ◀

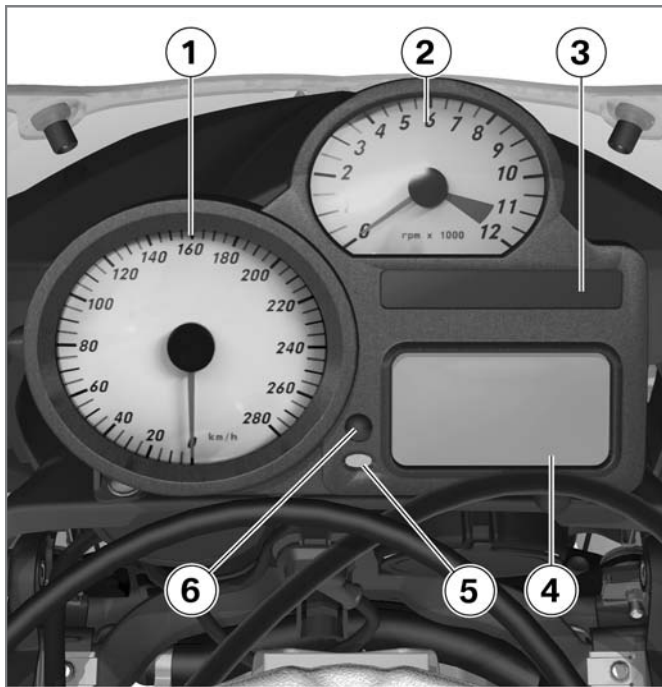

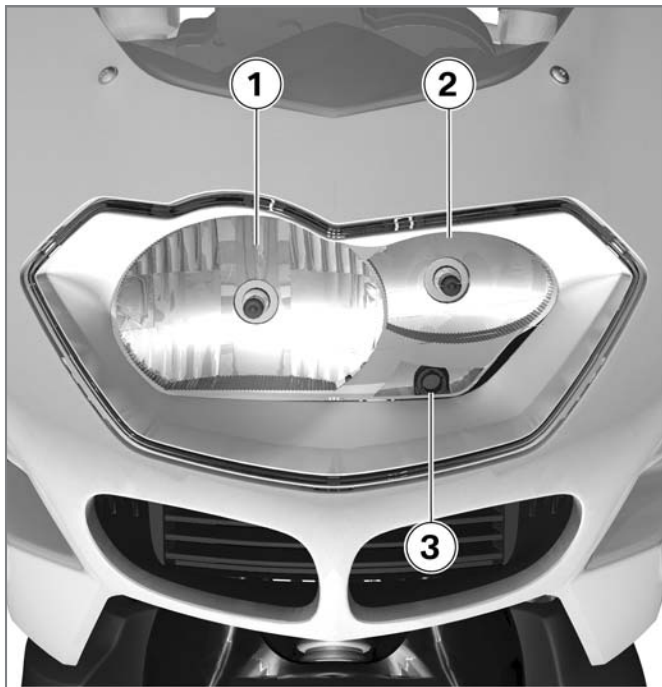

Headlight

- 1 High-beam headlights
- 2 Low-beam headlight
- 3 Side-light bulb

Status indicators

Multifunction display	22
Warning and telltale lights	22
ABS warning light ^{OE}	22
Function indicators	22
Warnings, general	23
Warnings issued by the tyre pressure monitoring system (RDC) ^{OE}	31
ABS warnings ^{OE}	35

Multifunction display

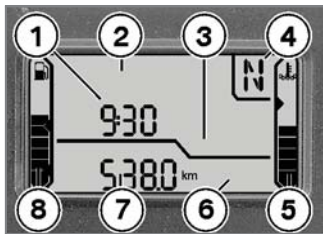

- 1 Clock (➡ 44), Panel for RDC status indicators^{OE} (➡ 46), Panel for oil-level information^{OE} (➡ 49)
- 2 Panel for warnings (➡ 23)
- 3 Panel for the on-board computer's status indicators^{OE} (➡ 46)
- 4 Gear indicator (➡ 22)
- 5 Coolant temperature readout (➡ 23)
- 6 Panel for ESA status indicators^{OE} (➡ 61)

- 7 Odometer reading (➡ 43)
- 8 Fuel gauge (➡ 22)

Warning and telltale lights

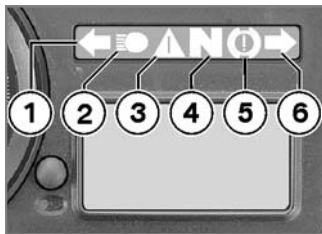

- 1 Telltale light, left turn indicator
- 2 Telltale light, high-beam headlight
- 3 Warning light, general
- 4 Telltale light, neutral
- 5 Warning light, ABS (OE)
- 6 Telltale light, right turn indicator

ABS warning light^{OE}

The way in which the ABS warning light indicates status can differ in some countries.

 Possible national variant.

Function indicators

Fuel capacity

 The horizontal bars below the fuel-pump symbol indicate the remaining quantity of fuel.

Gear

 Shows which gear is engaged. If no gear is engaged, the gear indicator shows N and the 'neutral' telltale light also lights up.

Coolant temperature















The horizontal bars below the temperature symbol indicate the coolant temperature.



Warnings, general

Mode of presentation

General warnings are displayed by means of warning lights or by messages and symbols in the multifunction display. In some cases, they are accompanied by the 'General' warning light showing red or yellow. If two or more warnings occur at the same time, all the appropriate telltale lights and warning symbols appear. Warnings in plain-text form alternate.

Warnings, overview

		Meaning	
	Lights up yellow	The EWS ! warning appears on the display.	Electronic immobiliser active (➡ 26)
	Lights up yellow	The FUEL ! warning flashes.	Fuel down to reserve (➡ 26)
	Lights up red	 Temperature reading flashes	Coolant temperature too high (➡ 26)
	Lights up yellow	 Appears on the display	Engine electronics (➡ 27)
	Flashes red	 Appears on the display	Insufficient engine oil pressure (➡ 27)
		 Shows accompanied by the CHECK OIL warning	Engine-oil level too low (➡ 28)
	Lights up red	 Appears on the display	Insufficient battery charge current (➡ 28)
	Lights up yellow	The LAMPR ! warning appears on the display.	Rear light bulb defective (➡ 29)

		Meaning	
		The LAMPF ! warning appears on the display.	Front light bulb defective (➡ 29)
	Lights up yellow	The LAMPS ! warning appears on the display.	Bulbs defective (➡ 29)
		 Appears on the display	Ice warning (➡ 29)
		The DWALO ! warning appears on the display.	Battery of anti-theft alarm (OE) weak (➡ 30)
	Lights up yellow	The DWA ! warning appears on the display.	Anti-theft alarm battery flat (OE) (➡ 30)

Electronic immobiliser active

 General warning light shows yellow.

The EWS ! warning appears on the display.

The key being used is not authorised for starting, or communication between key and engine electronics is disrupted.

- Remove all other vehicle keys from the same ring as the ignition key.
- Use the reserve key.
- Have the defective key replaced, preferably by an authorised BMW Motorrad dealer.

Fuel down to reserve

 General warning light shows yellow.

The FUEL ! warning flashes.

 Lack of fuel can result in the engine misfiring and cutting out unexpectedly. Misfiring can damage the catalytic converter; a hazardous situation can result if the engine cuts out unexpectedly. Do not run the fuel tank dry. ◀

 The estimated residual range appears on the display. ◀

The fuel tank contains no more than the reserve quantity of fuel.

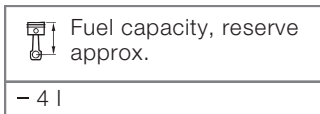

- Refuelling (➔ 73)

Coolant temperature too high

 General warning light lights up red.

 The temperature reading flashes.

 Continuing to ride when the engine is overheated could result in engine damage.

You must comply with the instructions below. ◀

The coolant temperature is too high.

- If possible, ride in the part-load range to cool down the engine.
- In traffic jams, switch off the engine, but leave the ignition switched on so that the radiator fan continues to operate.
- If the coolant temperature is frequently too high, have the fault rectified as soon as possible by a specialist workshop, preferably an authorised BMW Motorrad dealer.

Engine electronics

 General warning light shows yellow.

 Engine electronics symbol appears on the display.

 The engine is running in emergency operating mode. Engine power might be reduced and this can cause hazardous situations, particularly if you attempt to overtake other road users. Engine power level might be lower than normal: adapt your style of riding accordingly. ◀

The engine electronics control unit has diagnosed a fault. In exceptional cases, the engine stops and refuses to start. Otherwise, the engine runs in emergency operating mode.

- You can continue to ride, but bear in mind that the

usual engine power might not be available.

- Have the fault rectified as quickly as possible by a specialist workshop, preferably an authorised BMW Motorrad dealer.

Insufficient engine oil pressure

 General warning light flashes red.

 Engine oil pressure symbol appears on the display.

The oil pressure in the lube-oil system is too low. Stop immediately and switch off the engine if the warning light shows.

 The insufficient oil pressure warning does not fulfil the function of an oil gauge. The only way of checking whether the oil level

is correct is to check the oil level indicator. ◀

A low oil level is one reason why a warning indicating insufficient oil pressure is issued.

- Checking engine oil level (➡ 89)
- If the oil level is too low:
- Top up the engine oil (➡ 90)

If the warning indicating insufficient engine oil level is issued and a check indicates that the engine oil level is correct:

 Other engine problems besides a low oil level can cause the insufficient engine oil pressure warning to be issued. Continuing to ride in these cases can cause engine damage.

If this warning is issued even though the engine oil level is

correct: do not continue to ride. ◀

- Do not continue your journey.
- Have the fault rectified as quickly as possible by a specialist workshop, preferably an authorised BMW Motorrad dealer.

Engine-oil level too low



Symbol for oil level shows, accompanied by the CHECK OIL warning. The electronic oil-level sensor has registered an excessively low oil level.

Checking the oil sight glass is the only way of ascertaining the exact engine-oil level. The next time you stop for fuel:

- Checking engine oil level (➡ 89)

If the oil level is too low:

- Top up the engine oil (➡ 90)

The oil sensor might be defective if the "Check oil level" message appears even though a check of the oil sight glass shows that the oil level is correct.

- Seek the advice of a specialist workshop, preferably an authorised BMW Motorrad dealer.

Insufficient battery charge current



General warning light lights up red.



Battery charge current symbol is displayed.



A discharged battery can cause the engine to die suddenly, and this could result in a dangerous situation in traffic.

Have faults rectified as soon as possible. ◀



If the battery is not charging, continuing to ride can cause it to discharge completely, in which case it will suffer irreparable damage. If possible, do not continue your journey. ◀

Battery is not being charged.

- You can continue to ride until the battery is discharged. Bear in mind, however, that the engine could cut out suddenly and that the battery could discharge until completely flat, in which case it might have suffered irreparable damage.
- Have the fault rectified as quickly as possible by a specialist workshop, preferably an authorised BMW Motorrad dealer.

Rear light bulb defective



General warning light shows yellow.

The LAMP R ! warning appears on the display.



A defective bulb places your safety at risk because it is easier for other users to oversee you and your motorcycle.

Replace defective bulbs as soon as possible; always carry a complete set of spare bulbs if possible. ◀

Rear light or brake light bulb defective.

- Replacing brake light and rear light bulb (➡ 113)

Front light bulb defective

The LAMP F ! warning appears on the display.



A defective bulb places your safety at risk because it is easier for other users to oversee you and your motorcycle.

Replace defective bulbs as soon as possible; always carry a complete set of spare bulbs if possible. ◀

Low-beam headlight, high-beam headlight, side-light or turn-indicator bulb defective.

- Replacing low-beam and high-beam headlight bulb (➡ 109)
- Replacing parking-light bulb (➡ 111)
- Replacing turn indicator bulbs, front and rear (➡ 114)

Bulbs defective



General warning light shows yellow.

The LAMP S ! warning appears on the display.



A defective bulb places your safety at risk because it is easier for other users to oversee you and your motorcycle.

Replace defective bulbs as soon as possible; always carry a complete set of spare bulbs if possible. ◀

A combination of the bulb defects described above has occurred.

- See the fault descriptions above.

Ice warning



Ice warning symbol appears on the display.

The air temperature measured at the motorcycle is lower than 3 °C.



The ice warning does not mean that there is no risk of black ice forming at measured temperatures above 3 °C.

Always take extra care and think well ahead when temperatures are low; remember that the danger of black ice is particularly high on bridges and where the road is in the shade.◀

- Ride carefully and think well ahead.

Battery of anti-theft alarm (OE) weak

The DWALO ! warning appears on the display.



This error message appears only briefly after the pre-ride check completes.◀

The integral battery in the anti-theft alarm has lost a significant proportion of its original capacity. There is no assurance of how long the anti-theft alarm can remain operational if the motorcycle's battery is disconnected.

- Seek the advice of a specialist workshop, preferably an authorised BMW Motorrad dealer.

Anti-theft alarm battery flat (OE)



General warning light shows yellow.

The DWA ! warning appears on the display.

The integral battery in the anti-theft alarm has lost its entire original capacity. There is no assurance that the anti-theft alarm will be operational

if the motorcycle's battery is disconnected.

- Seek the advice of a specialist workshop, preferably an authorised BMW Motorrad dealer.

Warnings issued by the tyre pressure monitoring system (RDC)^{OE}



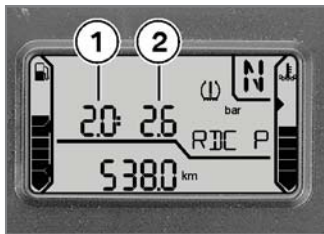





Display mode for RDC warnings



The tyre pressure for the front wheel **1** and the tyre pressure for the rear wheel **2** appear in the panel for the clock or the on-board computer, accompanied by the letters RDC. The critical tyre pressure flashes.

If the critical value is close to the limit of the permissible tolerance range, the reading is accompanied by the 'General' warning light showing yellow. If the tyre pressure registered by the sensor is outside the permissible tolerance range, the 'General' warning light flashes red.

Warnings, overview

		Meaning		
	Lights up yellow		The critical tyre pressure flashes	Tyre pressure close to limit of permitted tolerance (⇒ 33)
	Flashes red		The critical tyre pressure flashes	Tyre pressure outside permitted tolerance (⇒ 33)
			-- or -- -- appears on the display.	Signal transmission disrupted (⇒ 34)
	Lights up yellow		Indicated by -- or -- --	Sensor defective or system error (⇒ 34)
	Lights up yellow		Indicated by the letters RDC ! appearing on the display.	Tyre-pressure sensor battery weak (⇒ 35)

Tyre pressure close to limit of permitted tolerance



General warning light shows yellow.



The critical tyre pressure flashes.

Measured tyre pressure is close to the limit of permitted tolerance.

- Correct the tyre pressure as stated on the inside cover of the Rider's Manual.



The tyre-pressures listed on the inside cover are temperature-compensated; the reference tyre temperature for these readings is always 20 °C. The procedure for correctly tyre pressures when the tyres are not at this reference temperature is as follows:

Calculate the difference between the specified value stated in the Rider's Manual

and the reading shown by the RDC system. Use the public air line at a petrol station or motorway service area to adjust the tyre pressure by this amount.◀

Tyre pressure outside permitted tolerance



General warning light flashes red.



The critical tyre pressure flashes.

Measured tyre pressure is outside permitted tolerance.

- Check the tyre for damage and to ascertain whether the motorcycle can be ridden with the tyre in its present condition.

If the motorcycle can be ridden with the tyre in its present condition:



Incorrect tyre pressures impair the motorcycle's handling characteristics. If tyre pressure is incorrect it is essential to adapt your style of riding accordingly.◀

- Correct the tyre pressure at the earliest possible opportunity.
- Have the tyre checked for damage by a specialist workshop, preferably an authorised BMW Motorrad dealer.

If you are unsure whether the motorcycle can be ridden with the tyre in its present condition:

- Do not continue your journey.
- Notify the breakdown service.
- Have the tyre checked for damage by a specialist workshop, preferably an

authorised BMW Motorrad dealer.

Signal transmission disrupted

-- or --- appears on the display.

The motorcycle has not yet accelerated past the threshold of approximately 30 km/h. The RDC sensors do not start transmitting signals until the motorcycle reaches a speed above this threshold (➔ 74).

- Increase speed above this threshold observe the RDC readings. Assume that a permanent fault has not occurred unless the 'General' warning light comes on to accompany the symptoms. Under these circumstances:
- Have the fault rectified by a specialist workshop, prefer-

ably an authorised BMW Motorrad dealer.

Wireless communication with the RDC sensors has been disrupted. Possible causes include radio-communication systems operating in the vicinity and interfering with the link between the RDC control unit and the sensors.

- Move to another location and observe the RDC readings. Assume that a permanent fault has not occurred unless the 'General' warning light comes on to accompany the symptoms. Under these circumstances:
- Have the fault rectified by a specialist workshop, preferably an authorised BMW Motorrad dealer.

Sensor defective or system error



General warning light shows yellow.



Indicated by -- or ---.

Motorcycle is fitted with tyres not equipped with RDC sensors.

- Fit wheels and tyres equipped with RDC sensors.
- One or two RDC sensors have failed.
- Have the fault rectified by a specialist workshop, preferably an authorised BMW Motorrad dealer.

A system error has occurred.

- Have the fault rectified by a specialist workshop, preferably an authorised BMW Motorrad dealer.

Tyre-pressure sensor battery weak



General warning light shows yellow.



Indicated by the letters RDC ! appearing on the display.



This error message appears only briefly after the pre-ride check completes. ◀

The integral battery in the tyre-pressure sensor has lost a significant proportion of its original capacity. There is no assurance of how long the tyre pressure control system can remain operational.

- Seek the advice of a specialist workshop, preferably an authorised BMW Motorrad dealer.

ABS warnings^{OE}

Mode of presentation



ABS warnings are indicated by the ABS warning light. The warning light can show continuously or flash. The way in which the ABS warning light indicates status can differ in some countries.



Possible national variant.

Warnings, overview

Meaning



Flashes

Self-diagnosis not completed
(➡ 37)



Lights up

ABS fault (➡ 37)

Self-diagnosis not completed



ABS warning light flashes.

The ABS function is not available, because self-diagnosis did not complete. The motorcycle has to move forward a few metres for the wheel sensors to be tested.

- Pull away slowly. Bear in mind that the ABS function is not available until self-diagnosis has completed.

ABS fault



ABS warning light ON.

The ABS control unit has detected a fault. The ABS function is not available.

- You can continue to ride. Bear in mind that the ABS function is not available. Bear in mind the more de-

tailed information on situations that can lead to an ABS fault (➡ 78).

- Have the fault rectified as quickly as possible by a specialist workshop, preferably an authorised BMW Motorrad dealer.

Operation

Ignition switch and steering lock.....	40	Turn indicators	54
Electronic immobiliser (EWS) ...	41	Seat	55
Hazard warning flashers	42	Helmet holder	57
Odometer and tripmeters	43	Luggage loops	57
Clock	44	Mirrors	58
Tyre pressure monitoring RDC ^{OE}	46	Spring preload	59
On-board computer ^{OE}	46	Shock absorbers	60
Emergency off switch (kill switch)	50	Electronic Suspension Adjustment ESA ^{OE}	61
Grip heating ^{OE}	50	Tyres	62
Clutch	51		
Brakes	51		
Lights	52		
Headlight	53		

Ignition switch and steering lock

Keys

You receive one master key and one spare key. Please consult the information on the electronic immobiliser (EWS) if a key is lost or mislaid (➔ 41).

Ignition switch and steering lock, tank filler cap lock and seat lock are all operated with the same key.

with OA Case:

If you wish you can arrange to have the cases fitted with locks that can be opened with this key as well. Consult a specialist workshop, preferably an authorised BMW Motorrad dealer.◀

Switching on ignition

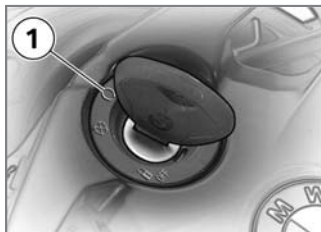

- Turn the key to position **1**.
 - » Side light and all function circuits switched on.
 - » Engine can be started.
 - » Pre-ride check is performed. (➔ 69)

with OE BMW Motorrad Integral ABS:

- Turn the key to position **1**.
 - » ABS self-diagnosis is performed in addition to the checks outlined above. (➔ 70)◀

Switching off ignition

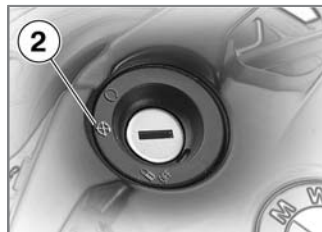

- Turn the key to position **2**.
 - » Lights switched off.
 - » Handlebars not locked.
 - » Key can be removed.
 - » Electrically powered accessories remain operational for a limited period of time.
 - » The battery can be recharged via the on-board socket.

Locking handlebars



! If the motorcycle is on the side stand, the surface of the ground will determine whether it is better to turn the handlebars to the left or right. However, the motorcycle is more stable on a level surface with the handlebars turned to the left than with the handlebars turned to the right.

On level ground, always turn the handlebars to the left to set the steering lock. ◀

- Turn the handlebars to the full left or right lock position.
- Turn the key to position **3**, while moving the handlebars slightly.
 - » Ignition, lights and all function circuits switched off.
 - » Handlebars locked.
 - » Key can be removed.

Electronic immobiliser (EWS)

Protection against theft

The electronic immobiliser helps protect your BMW motorcycle from theft, and this enhanced security is at your disposal without any need for you to set parameters or activate additional systems. The engine of a motorcycle fitted with this electronic immobiliser can be started only with the keys that belong to the vehicle. You can also have

your authorised BMW Motorrad dealer bar individual keys, for example if a particular key goes missing. The engine cannot be started with a key that has been barred.

In-key electronics

The motorcycle's electronics exchange certain continuously changing signals with the electronics in the key; these signals are specific to your motorcycle and they are transmitted via the ring aerial in the ignition lock. The ignition is not enabled for starting until the key has been recognised as "authorised" for your motorcycle.

▷ A spare key attached to the same ring as the ignition key used to start the engine could "irritate" the electronics, in which case the enabling signal for starting is

not issued. The EWS warning appears in the multifunction display.

Always keep the spare key separately from the ignition key. ◀

Replacement and extra keys

You can obtain replacement/extra keys only through an authorised BMW Motorrad dealer. The keys are part of an integrated security system, so the dealer is under an obligation to check the legitimacy of all applications for replacement/extra keys. If you want to have a lost key barred, you have to bring with you all the other keys that belong to the motorcycle. A key that has been barred can subsequently be cleared and reactivated for use.

Hazard warning flashers

Switching on hazard warning flashers

- Switch on the ignition.

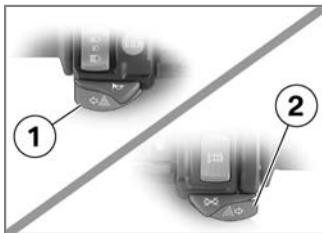

- Simultaneously press button **1** for left turn indicators and button **2** for right turn indicators.

▶ The hazard warning flashers place a strain on the battery. Do not use the hazard warning flashers

for longer than absolutely necessary. ◀

▶ If you press a turn-indicator button with the ignition switched on, the turn-indicator function is activated instead of the hazard warning flashers, and remains active until you release the button. The hazard warning flashers recommence flashing as soon as the button is released. ◀

- » Hazard warning flashers in operation.
- » Left/right turn indicator tell-tale lights flash.
- Switch off the ignition.
- » The hazard warning flashers continue to operate.
- » Left/right turn indicator tell-tale lights off.

Switching off hazard warning flashers

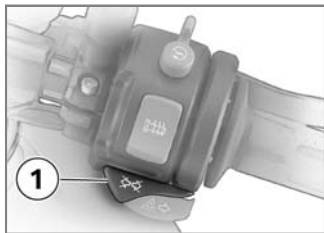

- Press cancel button **1**.
- » Hazard warning flashers switched off.

Odometer and tripmeters

Operating the odometer



If the motorcycle is not equipped with on-board computer and RDC, you have the alternative of using INFO button **1** to operate the odometer as described here.

Selecting readings

- Switch on the ignition.

▶ When you switch on the ignition, the odometer reading shown when the ignition was switched off always

reappears on the multifunction display. ◀

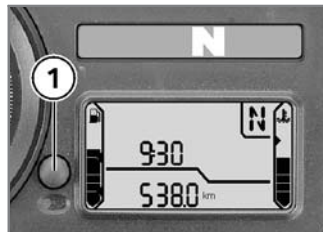

- Press button **1** once briefly.

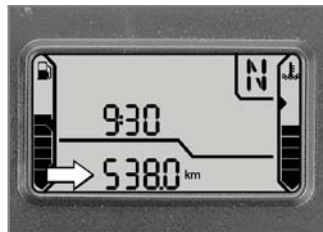

The display starts with the current value and each time the button is pressed it

moves one step through the following sequence:

- Total distance covered
- Tripmeter 1 (Trip I)
- Tripmeter 2 (Trip II)
- Residual range (without on-board computer, once fuel level is down to reserve)

Resetting tripmeter

- Switch on the ignition.
- Select the desired tripmeter.

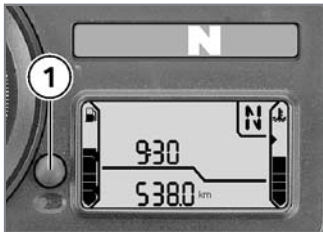

- Press and hold down button **1** until the reading changes.
- » The tripmeter is reset to zero.

Residual range without OE On-board computer:

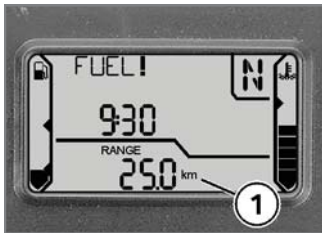

The residual-range readout **1** indicates how far you can ride with the fuel remaining in the tank. This reading is not displayed until fuel level has dropped to reserve. This distance is calculated on the basis of fuel level and average consumption.

When you refuel, the increase in fuel level is not registered unless several litres are ad-

ded to the fuel already in the tank.

▶ The calculated range is an approximate value. Consequently, BMW Motorrad recommends that you should not try to use the full residual range before refuelling. ◀

Clock

Setting clock



Attempting to set the clock while riding the motorcycle can lead to accidents.

Set the clock only when the motorcycle is stationary. ◀

- Switch on the ignition.

without OE On-board computer:

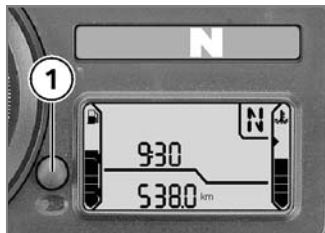

- Repeatedly press button **1** until the odometer reading appears on the display.◀

with OE On-board computer:



- Repeatedly press button **2** until the clock appears on the display.

▶ In this case, the button in the instrument cluster operates only the tripmeters.◀

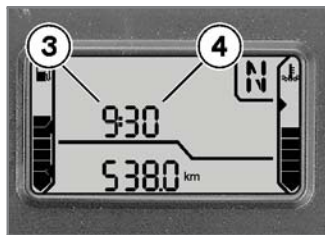

- Hold down the button.
 - » Hours reading **3** flashes.
- Press the button.
 - » The hours reading increments by one each time you press the button.
- Hold down the button.
 - » Minutes reading **4** flashes.
- Press the button.
 - » The minutes reading increments by one each time you press the button.
- Hold down the button.
 - » The clock is now set and the time appears on the display.

Tyre pressure monitoring RDC^{OE}

Viewing tyre-pressure readings

- Switch on the ignition.



- Repeatedly press INFO button **1** until the tyre pressures appear in the display.



The tyre-pressure readings alternate with the clock. The front tyre pressure is on the left; the reading on the right is the rear tyre pressure. If your motorcycle is fitted with an on-board computer, the tyre pressures are displayed as an additional set of readings by the on-board computer.

On-board computer^{OE}

Selecting readings

- Switch on the ignition.



- Press INFO button **1** once at each step.



The on-board computer's display field starts with the current value and cycles through the following sequence:

- Ambient temperature
- Average speed
- Average consumption
- Range
- Oil level
- Tyre pressures (OE)

Ambient temperature

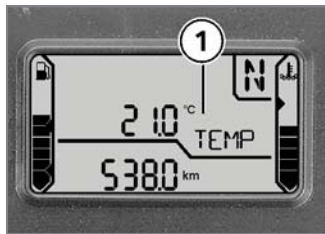

When the motorcycle is at a standstill the heat of the engine can falsify ambient-temperature reading **1**. If the effect of the engine's heat becomes excessive, -- temporarily appears on the display.

 An ice warning appears if the ambient-temperature reading drops below 3 °C. The display automatically switches from any other mode to the temperature reading when the temperature drops below this threshold for the first time.

Average speed



Average speed **1** is calculated on the basis of the time elapsed since the last reset. Times during which the engine was stopped are excluded from the calculation.

Resetting average speed



- Repeatedly press INFO button **1** until the average speed appears in the display.
- Press and hold down the INFO button until the reading changes ("RESET").
- » The display shows "--- km/h".

Average consumption



Average consumption **1** is calculated by dividing the distance covered since the last reset by the corresponding amount of fuel used.

Resetting average consumption



- Repeatedly press INFO button **1** until the average fuel consumption appears in the display.
- Press and hold down the INFO button until the reading changes ("RESET").
- » The display shows "--.- l/100 km".

Range

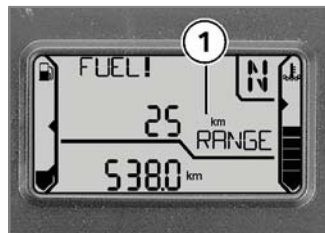

The description of the residual-range function (➔ 44) also covers the residual-range readout. You can also view range **1** before the fuel level drops to reserve. A special average-consumption figure is used to calculate range; this figure is not necessarily the same as the value you can call up for viewing on the display.

▶ The calculated range is only an approximate reading. Consequently, BMW Motorrad recommends that you should not try to use the full range before refuelling. ◀

Oil level



Oil-level indicator **1** gives you an indication of the engine oil level. You can call up this reading only when the motorcycle is at a standstill.

The preconditions for the oil level check are as follows:

- Engine at operating temperature.
- Engine idling for at least 10 seconds.
- Side stand retracted.
- Make sure the motorcycle is upright.

The readings mean:

OK: Oil level is correct.

CHECK: Check the oil level the next time you stop for fuel.



Remains visible until the sensor subsequently registers a correct oil level.

---: Oil level cannot be measured (conditions as stated above not satisfied).

The most recently measured level is displayed for 5 seconds when you next switch on the ignition.

▶ The oil sensor might be defective if the "Check oil level" message reappears even though the oil level in the oil sight glass is correct. In this case, consult your authorised BMW Motorrad dealer. ◀

Emergency off switch (kill switch)

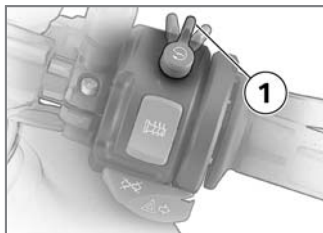

- 1** Emergency off switch (kill switch).

! Operating the kill switch when riding can cause the rear wheel to lock and thus cause a fall.

Do not operate the kill switch when riding. ◀

The emergency off switch is a kill switch for switching off the engine quickly and easily.

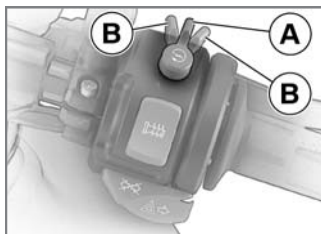

- A** Normal operating position (run)
B Engine switched off.

▶ You cannot start the engine unless the kill switch is in the run position. ◀

Grip heating^{OE}

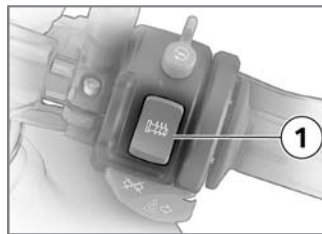

- 1** Grip heating switch

The handlebar grips have two-stage heating. Grip heating can be activated only when the engine is running.

▶ The increase in power consumption caused by the grip heating can drain the battery if you are riding at low engine speeds. If the charge level is low, grip heating is switched off to ensure the battery's starting capability. ◀

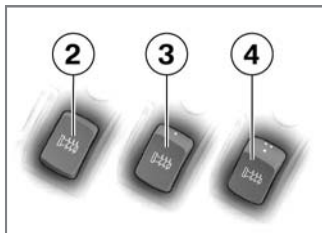

- 2 Heating off.
- 3 50 % heat output (one dot visible).
- 4 100 % heat output (three dots visible)

Clutch

Adjusting the clutch lever

! If the position of the clutch fluid reservoir is changed, air can enter the clutch system.

Do not twist the handlebar fitting or the handlebars. ◀

! Attempting to adjust the clutch lever while riding the motorcycle can lead to accidents.

Do not attempt to adjust the clutch lever unless the motorcycle is at a standstill. ◀

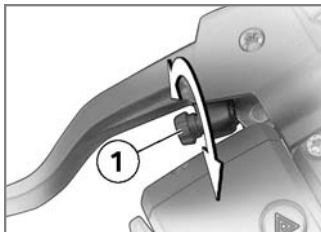

- Turn adjusting screw **1** clockwise.

▶ The adjusting screw is indexed and is easier to turn if you push the clutch lever forward. ◀

- » Span between handlebar grip and clutch lever increases.

- Turn adjusting screw **1** counter-clockwise.
- » Span between handlebar grip and clutch lever decreases.

Brakes

Adjusting the handbrake lever

! Changing the position of the brake-fluid reservoir can allow air to penetrate the brake system.

Do not twist the handlebar fitting or the handlebars. ◀

! Attempting to adjust the brake lever while riding the motorcycle can lead to accidents.

Do not attempt to adjust the brake lever unless the motorcycle is at a standstill. ◀

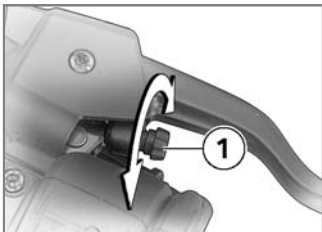

- Turn adjusting screw **1** clockwise.

▷ The adjusting screw is indexed and is easier to turn if you push the handbrake lever forward.◀

- » Span between handlebar grip and handbrake lever increases.
- Turn adjusting screw **1** counter-clockwise.
- » Span between handlebar grip and handlebar lever decreases.

Lights

Side light

The side lights switch on automatically when the ignition is switched on.

▷ The side lights place a strain on the battery. Do not switch the ignition on for longer than absolutely necessary.◀

Low-beam headlight

The low-beam headlight switches on automatically when you start the engine.

▷ When the engine is not running you can switch on the lights by switching on the ignition and either switching on the high-beam headlight or operating the headlight flasher.◀

Switching on high-beam headlight



- Press the top part of switch **1** for the high-beam headlight.
- » High-beam headlight switched on.
- Move switch **1** for the high-beam headlight to the centre position.
- » High-beam headlight switched off.
- Press the bottom section of switch **1** for the high-beam headlight.

- » The high-beam headlight is switched on until you release the button (headlight flasher).

Switching on parking lights

- Switch off the ignition.

 You can switch on the parking lights only immediately after switching off the ignition. ◀



- Press and hold down switch **1** for the left turn indicators

until the parking lights are ON.

Switching off parking lights

- Switch the ignition on and then off again.
- » Parking lights switched off.

Headlight

Adjusting headlight for driving on left/driving on right

If the motorcycle is ridden in a country where the opposite rule of the road applies, its asymmetric low-beam headlight will tend to dazzle oncoming traffic.

Have the headlight set accordingly by a specialist workshop, preferably an authorised BMW Motorrad dealer.



Commercially available adhesive tape will damage the plastic lens of the light.

Consult a specialist workshop, preferably an authorised BMW Motorrad dealer, in order to avoid damaging the plastic lens of the light. ◀

Headlight beam throw and spring preload

Headlight beam throw is generally kept constant when spring preload is adjusted to suit load.

Spring preload adjustment might not suffice only if the motorcycle is very heavily loaded. Under these circumstances, headlight beam throw has to be adjusted to suit the weight carried by the motorcycle.

▶ Consult a specialist workshop, preferably an authorised BMW Motorrad dealer, if you are unsure whether the headlight basic setting is correct. ◀

Headlight beam-throw adjustment

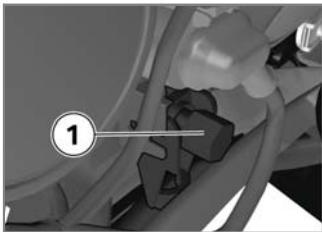

- 1 Headlight beam-throw adjustment

Spring preload adjustment might not suffice if the motorcycle is very heavily loaded. Moving the pivot lever adjusts

headlight beam throw so as not to dazzle oncoming traffic.

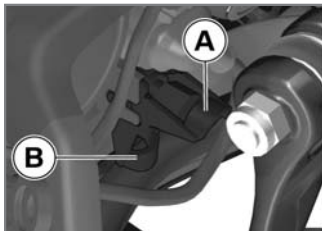

- A Neutral position
B Position for heavy load

Turn indicators Switching on left flashing turn indicators

- Switch on the ignition.



- Press left-hand turn indicator or button 1.

▶ The turn indicators are cancelled automatically after you have ridden for approximately 10 seconds, or covered a distance of about 200 m. ◀

- » Left-hand turn indicators switched on.
- » Telltale light for left-hand turn indicators flashes.

Switching on right flashing turn indicators

- Switch on the ignition.

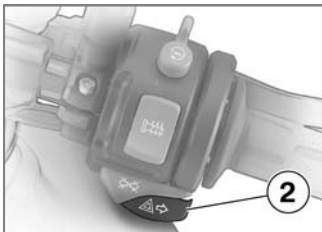

- Press right-hand turn indicator button **2**.

▶ The turn indicators are cancelled automatically after you have ridden for approximately 10 seconds, or covered a distance of about 200 m.◀

- » Right-hand turn indicators switched on.
- » Telltale light for right-hand turn indicator flashes.

Cancelling turn indicators

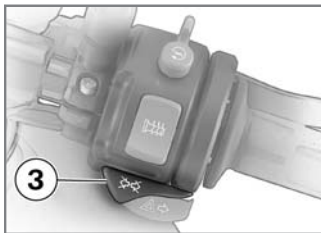

- Press cancel button **3**.
- » Flashing turn indicators switched off.
- » Turn indicator telltale light is off.

Seat

Removing the seat

- Make sure the ground is level and firm and place the motorcycle on its stand.



- Turn the key counter-clockwise in the seat lock.

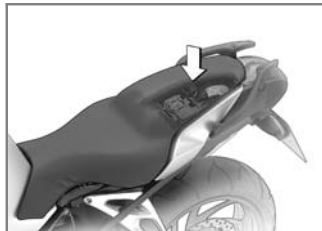

- Press the seat down at the same time.

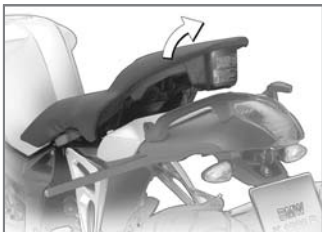

- Lift the rear of the seat.

! The seat can be damaged at the edges if it is placed on a rough surface. Lay the seat upholstered side down on a smooth, clean surface, such as the fuel tank. ◀

- Release the key and pull the seat back out of its holder.

Installing the seat



! If too much pressure is applied in the forward direction, there is a danger that the motorcycle will be pushed off its stand.

Always make sure that the motorcycle is stable and firmly supported. ◀

- Push the seat forward into holders **1**.

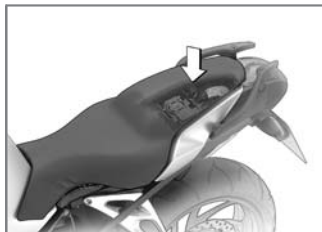

- Push down firmly on the seat, applying pressure to the point above the latch.
 - » The seat engages with an audible click.

Helmet holder

Helmet holder underneath seat

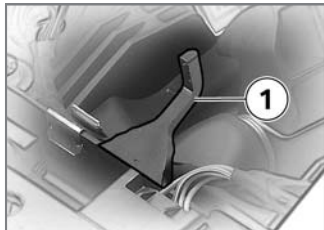

Helmet holder **1** is underneath the seat.

A motorcycle helmet with chin strap can be attached to the helmet holder. If cases are fitted or if the chin strap is too short, a steel cable can be used to secure the motorcycle helmet.

Using helmet holder

- Make sure the ground is level and firm and place the motorcycle on its stand.
- Removing the seat (➔ 55)

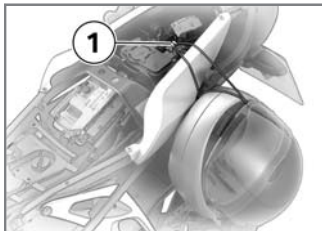

! The helmet catch can scratch the panelling. Make sure the lock is out of the way when you hook the helmet into position. ◀

! On the right-hand side of the motorcycle, the helmet could be damaged by heat from the end silencer. Attach the helmet on the left-

hand side of the motorcycle only. ◀

- Use the wire rope available as an optional extra to secure the helmet to helmet holder **1**.

Luggage loops

Luggage loops underneath seat

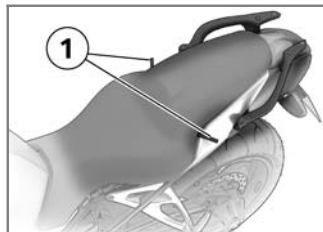

Loops **1** for attaching luggage straps are located on the underside of the seat.

Using luggage loops

- Make sure the ground is level and firm and place the motorcycle on its stand.
- Removing the seat (➔ 55)
- Turn the seat upside down.

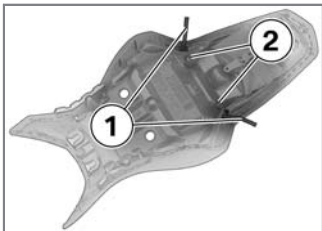

- Pull loops **1** out of holders **2**.
- » You can hook luggage straps into the loops.

Mirrors

Adjusting mirrors



- Move the mirror to the desired position by pressing it lightly close to the edge.

Adjusting mirror arm

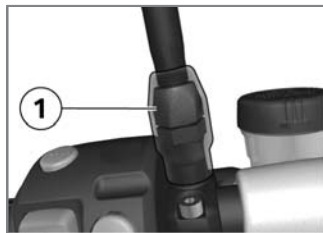

- Push the protective cap up over the threaded fastener on the mirror arm.
- Back off nut **1** by turning it clockwise (left-hand thread).
- Turn the mirror arm to the appropriate position.
- Retighten the nut.



Mirror to clamping piece

– 22 Nm

- Push the protective cap over the threaded fastener.

Spring preload

Spring preload and weight

It is essential to set spring preload to suit the load carried by the motorcycle. Increase spring preload when the motorcycle is heavily loaded and reduce spring preload accordingly when the motorcycle is lightly loaded.

Adjusting spring preload for rear wheel

 Your motorcycle's handling will suffer if you do not match the spring-preload and damping-characteristic settings.

Adjust the damping characteristic to suit spring preload. ◀

 Adjusting spring preload while the motorcycle is being ridden can lead to accidents.

Do not attempt to adjust spring preload unless the motorcycle is at a standstill. ◀

- Make sure the ground is level and firm and place the motorcycle on its stand.

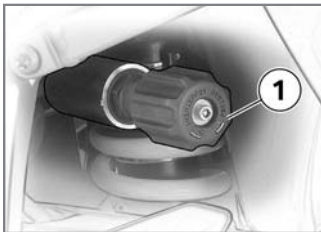

- If you want to increase spring preload, turn knob **1** in the direction indicated by the HIGH arrow.
- If you want to reduce spring preload, turn knob **1** in the

direction indicated by the LOW arrow.

 One click corresponds to a half turn of the knob. The range of adjustment comprises 15 turns. ◀

 Spring preload, basic setting

- Turn the knob as far as it will go in the direction indicated by the LOW arrow and then turn it back 13 clicks in the direction indicated by the HIGH arrow. (Full load of fuel, with rider 85 kg)

Shock absorbers

Shock-absorber settings and spring preload

Damping must be adapted to suit spring preload. An increase in spring preload requires firmer damping, a reduction in spring preload requires softer damping.

Adjusting rear shock absorber

 Your motorcycle's handling will suffer if you do not match the spring-preload and damping-characteristic settings.

Adjust the damping characteristic to suit spring preload. ◀

- Make sure the ground is level and firm and place the motorcycle on its stand.

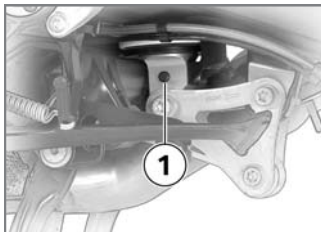

- Adjust the rear shock absorber, using a screwdriver to turn adjusting screw **1**.



- If you want a harder damping characteristic, use a screwdriver to turn the adjusting screw in the direc-

tion indicated by the H arrow.

- If you want a softer damping characteristic, use a screwdriver to turn the adjusting screw in the direction indicated by the S arrow.

 The adjusting screw can be turned through three and a half turns. ◀



Rear suspension damping, basic setting

- Turn the adjusting screw as far as it will go in the direction indicated by the H arrow and then turn it back one and a half turns in the direction indicated by the S arrow. (One-up 85 kg)

Electronic Suspension Adjustment ESA^{OE}

Settings

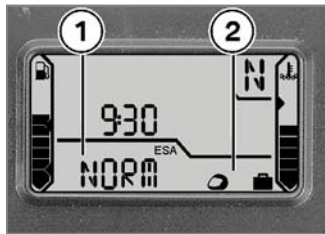

Electronic Suspension Adjustment ESA provides a convenient way of adapting the motorcycle to different conditions. Three spring preload settings can be combined with three damping characteristics to fine-tune the motorcycle's suspension to the load it carries and the surface over which you want to ride. The damping characteristic is shown in panel **1** of the mul-

tifunction display, and spring preload in panel **2**.

The odometer readings are not shown while the ESA readout is active.

Calling up settings

- Switch on the ignition.



- Press button **1**.
 - » The current setting is displayed.
 - » The reading remains visible for a few seconds before disappearing automatically.

Adjusting suspension damping

- Switch on the ignition.

 You can adjust the damping characteristic while the motorcycle is on the move. ◀



- Press button **1**.
 - » The current setting is displayed.
- Press button **1** once briefly. The display field starts at the current status and cycles through the following sequence:

- COMF Comfortable damping characteristic
 - NORM Normal damping characteristic
 - SPORT Sporty damping characteristic
- » The setting shown on the display is automatically accepted as the damping characteristic if you allow a certain length of time to pass without pressing button **1**. During the setting procedure, the display flashes.

Adjusting spring preload

- Start the engine.

 You cannot adjust spring preload while the motorcycle is on the move.◀



- Press button **1**.
 - » The current setting is displayed.
- Press and hold down button **1** until the reading changes.

The display field starts at the current status and cycles through the following sequence:

 One-up

 One-up with luggage

 Two-up (with luggage)

- The setting shown on the display is automatically accepted as the spring preload if you allow a certain length of time to pass without pressing button **1**. During the setting procedure, the display flashes.

Tyres

Check the tyre pressures

 Incorrect tyre pressures impair the motorcycle's handling characteristics and can lead to accidents. Always check that the tyre pressures are correct.◀

 At high road speeds, tyre valves have a tendency to open as a result of centrifugal force. In order to avoid a sudden

loss of tyre pressure, fit a metal valve cap with rubber sealing ring to the rear tyre and make sure that the cap is screwed on firmly.◀



Incorrect tyre pressure reduces the operating life of the tyres.

Always check that the tyre pressures are correct.◀

- Check that tyre pressures are correct as per the data below.



Tyre pressure, front

– 2.5 bar (One-up, tyre cold)

– 2.5 bar (Two-up and/or with luggage, tyre cold)



Tyre pressure, rear

– 2.9 bar (One-up, tyre cold)

– 2.9 bar (Two-up and/or with luggage, tyre cold)

If tyre pressure is too low:

- Correct the tyre pressures.

Riding

Safety instructions	66
Checklist	68
Starting	68
Running in	70
Parking your motorcycle	71
Refuelling	73
Tyre pressure monitoring RDC ^{OE}	74
Brake system, general	75
Brake system with BMW Motorrad ABS ^{OE}	76

Safety instructions

Rider's equipment

Do not ride without the correct clothing. Always wear:

- Helmet
- Motorcycling jacket and trousers
- Gloves
- Boots

This applies even to short journeys, and to every season of the year. Your authorised BMW Motorrad dealer will be glad to advise you on the correct clothing for every purpose.

Speed

If you ride at high speed, always bear in mind that various boundary conditions can adversely affect the handling of your motorcycle:

- Settings of the spring-strut and shock-absorber system
- Imbalanced load
- Loose clothing
- Insufficient tyre pressure
- Poor tyre tread
- Etc.

Correct loading



Overloading and imbalanced loads can adversely affect the motorcycle's handling.

Do not exceed the permissible gross weight and be sure to comply with the instructions on loading. ◀

Alcohol and drugs



Even small amounts of alcohol or drugs will adversely affect your perception and your ability to assess situations and make decisions, and slow down your

reflexes. Medication can exacerbate these effects.

Do not ride your motorcycle after consuming alcohol, drugs and/or medication. ◀

Risk of poisoning

Exhaust fumes contain carbon monoxide, which is colourless and odourless but highly toxic.



Inhaling the exhaust fumes therefore represents a health hazard and can even cause loss of consciousness with fatal consequences.

Do not inhale exhaust fumes. Do not run the engine in an enclosed space. ◀

High voltage

 Touching live parts of the ignition system with the engine running can cause electric shock.

Do not touch parts of the ignition system when the engine is running. ◀

Catalytic converter

If misfiring causes unburned fuel to enter the catalytic converter, there is a danger of overheating and damage.

For this reason, observe the following points:

- Do not run the fuel tank dry.
- Do not attempt to start or run the engine with a spark-plug cap disconnected.
- Stop the engine immediately if it misfires.
- Use only unleaded fuel.
- Comply with all specified maintenance intervals.

 Unburned fuel will destroy the catalytic converter.

Note the points listed for protection of the catalytic converter. ◀

Risk of fire

Temperatures at the exhaust are high.

 Flammable materials (e.g. hay, leaves, grass, clothing and luggage, etc.) could ignite if allowed to come into contact with the hot exhaust pipe.

Do not permit flammable materials to come into contact with the hot exhaust system. ◀

 Cooling would be inadequate if the engine were allowed to idle for a lengthy period with the motorcycle at a standstill: overheating would result.

In extreme cases, the motorcycle could catch fire. Do not allow the engine to idle unnecessarily. Ride away immediately after starting the engine. ◀

Tampering with the control unit of the electronic engine-management system

 Tampering with the control unit of the electronic engine-management system can damage the motorcycle and cause accidents. Do not tamper with the control unit of the electronic engine-management system. ◀

 Tampering with the control unit of the electronic engine-management system can result in mechanical loads that the motorcycle's com-

ponents are not designed to withstand. Damage caused in this way is not covered by the warranty.

Do not tamper with the control unit of the electronic engine-management system. ◀

Checklist

Use the following checklist to check important functions, settings and wear limits before you ride off.

- Brakes
- Brake-fluid levels, front and rear
- Clutch
- Clutch fluid level
- Shock absorber setting and spring preload
- Tyre-tread depth and tyre pressures

- Cases correctly installed and luggage secured

At regular intervals:

- Engine oil level (every refuelling stop)
- Brake-pad wear (every third refuelling stop)

Starting

Side stand

You cannot start the motorcycle with the side stand extended and a gear engaged. The engine will switch itself off if you start it with the gearbox in neutral and then engage a gear before retracting the side stand.

Gearbox

You can start the engine when the gearbox is in neutral or if you pull the clutch with a gear engaged. Do not pull the clutch until after you have

switched on the ignition, as otherwise the engine will refuse to start. When the gearbox is in neutral, the green neutral telltale light is on and the gear indicator in the multifunction display shows N.

Starting engine

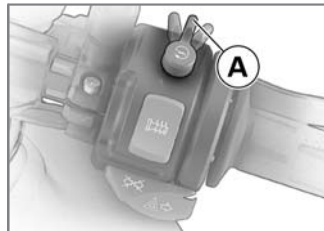

- Kill switch in run position **A**.
 - Switch on the ignition.
- » Pre-ride check is performed. (➔ 69)

with OE BMW Motorrad Integral ABS:

- Switch on the ignition.
 - » Pre-ride check is performed. (➡ 69)
 - » ABS self-diagnosis is performed. (➡ 70)◀

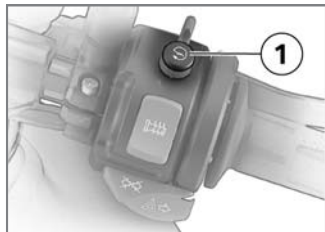

- Press starter button 1.

▶ If ambient temperatures are very low, you might find it necessary to open the throttle slightly when starting the engine. At ambient temperatures below 0 °C, disen-

gage the clutch after switching on the ignition.◀

▶ The start attempt is automatically interrupted if battery voltage is too low. Recharge the battery before you start the engine, or use jump leads and a donor battery to start.◀

- » The engine starts.
- » Consult the troubleshooting chart below if the engine refuses to start. (➡ 130)

Pre-ride check

The instrument cluster runs a test of the 'General' warning light when the ignition is switched on. The warning light shows first red and then yellow, so that you can check that it is in working order. This pre-ride check is indicated by the word CHECK! appearing in the display. The

test is aborted if you start the engine before it completes.

Phase 1

⚠ General warning light lights up red.

- The CHECK! reminder appears on the display.

Phase 2

⚠ General warning light shows yellow.

- The CHECK! reminder appears on the display.

If the 'General' warning light is not displayed:

⚠ Some malfunctions cannot be indicated if the 'General' warning light cannot be displayed.

Check that the 'General' warning light comes on, and that it lights up yellow and then red.◀

- Have the fault rectified as quickly as possible by a specialist workshop, preferably an authorised BMW Motorrad dealer.

ABS self-diagnosis^{OE}

BMW Motorrad ABS performs self-diagnosis to ensure its operability. Self-diagnosis is performed automatically when you switch on the ignition. The motorcycle has to move forward at a speed above 5 km/h for the wheel sensors to be tested.

Phase 1

- » Test of the diagnosis-compatible system components with the motorcycle at a standstill.

 ABS warning light flashes.



Possible national variant of the ABS warning light.

Phase 2

- » Test of the wheel sensors as the motorcycle pulls away from rest.



ABS warning light flashes.



Possible national variant of the ABS warning light.

ABS self-diagnosis completed

- » The ABS warning light goes out.

If an indicator showing an ABS fault appears when ABS self-diagnosis completes:

- You can continue to ride. Bear in mind that neither the ABS function nor the integral braking function is available.

- Have the fault rectified as quickly as possible by a specialist workshop, preferably an authorised BMW Motorrad dealer.

Running in

The first 1000 km

- While running in the motorcycle, vary the throttle opening and engine-speed range frequently.
- Try to do most of your riding during this initial period on twisting, fairly hilly roads, avoiding high-speed main roads and highways if possible.



Exceeding the specified engine speeds while running in will lead to increased engine wear.

Keep to the specified engine speeds for running in. ◀

- Do not exceed the rpm limits recommended for running in.

 Running-in speeds
– <7000 min ⁻¹

- No full-load acceleration.
- Avoid low engine speeds at full load.
- Do not omit the first inspection after 500 - 1200 km.

Brake pads

New brake pads must "bed down" and therefore do not achieve their optimum friction levels during the first 500 km. You can compensate for this initial reduction in braking efficiency by exerting greater pressure on the levers.

-  New brake pads can extend stopping distance by a significant margin.

Apply the brakes in good time. ◀

Tyres

New tyres have a smooth surface. This must be roughened by riding in a restrained manner at various heel angles until the tyres are run in. This running in procedure is essential if the tyres are to achieve maximum grip.

-  Tyres do not have their full grip when new and there is a risk of accidents at extreme angles of heel. Avoid extreme angles of heel. ◀

Parking your motorcycle

Place the motorcycle on side stand

 If the ground is soft or uneven, there is no guarantee that the motorcycle will rest firmly on the stand. Always check that the ground under the stand is level and firm. ◀

- Switch off the engine.
- Pull the handbrake lever.
- Hold the motorcycle upright and balanced.
- Use your left foot to extend the side stand fully.

 The side stand is designed to support only the weight of the motorcycle. Do not lean or sit on the motorcycle with the side stand extended. ◀

- Slowly lean the motorcycle to the side until its weight is taken by the stand and dismount to the left.

 If the motorcycle is on the side stand, the surface of the ground will determine whether it is better to turn the handlebars to the left or right. However, the motorcycle is more stable on a level surface with the handlebars turned to the left than with the handlebars turned to the right.

On level ground, always turn the handlebars to the left to set the steering lock.◀

- Turn the handlebars to full left or right lock.
- Check that the motorcycle is standing firmly.

 On a gradient, the motorcycle should always face uphill; select 1st gear.◀

- Lock the steering lock.

Remove the motorcycle from side stand

- Unlock the steering lock.
- From the left, grip the handlebars with both hands.
- Pull the handbrake lever.
- Swing your right leg over the seat and lift the motorcycle to the upright position.
- Hold the motorcycle upright and balanced.

 An extended side stand can catch on the ground when the motorcycle is moving and lead to a fall.

Retract the side stand before moving the motorcycle.◀

- Sit on the motorcycle and use your left foot to retract the side stand.

Place the motorcycle on centre stand^{OA}

 If the ground is soft or uneven, there is no guarantee that the motorcycle will rest firmly on the stand. Always check that the ground under the stand is level and firm.◀

- Switch off the engine.
- Dismount and keep your left hand on the left handlebar grip.
- With your right hand, grip the rear grab handle or the rear frame.
- Place your right foot on the pin of the centre stand, and press the stand down until its curved feet touch the ground.
- Place your full body weight on the centre stand and at the same time pull the motorcycle to the rear.

! Excessive movements could cause the centre stand to retract, and the motorcycle would topple in consequence.

Do not lean or sit on the motorcycle with the centre stand extended.◀

- Check that the motorcycle is standing firmly.
- Lock the steering lock.

Remove the motorcycle from centre stand^{OA}

- Unlock the steering lock.
- Place your left hand on the left handlebar grip.
- With your right hand, grip the rear grab handle or the rear frame.
- Push the motorcycle forward off the centre stand.
- Check that the centre stand has fully retracted.

Refuelling

! Fuel is highly flammable. A naked flame close to the fuel tank can cause a fire or explosion.

Do not smoke. Never bring a naked flame near the fuel tank.◀

! Fuel expands when hot. Fuel escaping from an overfilled tank could make its way onto the rear tyre. This could cause a fall.

Do not fill the tank past the bottom edge of the filler neck.◀

! Fuel attacks plastics, which become dull or unsightly.

Wipe off plastic parts immediately if they come into contact with fuel.◀

! Leaded fuel will destroy the catalytic converter. Use only unleaded fuel.◀

- Make sure the ground is level and firm and place the motorcycle on its stand.



- Open the protective cap.
- Open the fuel tank cap with the ignition key by turning it counter-clockwise.



- Refuel with fuel of the grade stated below; do not fill the tank past the bottom edge of the filler neck.

 Recommended fuel grade

– 98 ROZ/RON (Premium plus unleaded)

– 95 ROZ/RON (Premium unleaded (fuel grade, usable with power- and consumption-related restrictions))

 Fuel capacity, usable

– 19 l

 Fuel capacity, reserve approx.

– 4 l

- Press the filler cap down firmly to close.
- Remove the key and close the protective cap.

Tyre pressure monitoring RDC^{OE}

Function

A sensor integrated into each tyre measures the air temperature and the air pressure inside the tyre and transmits this information to the control unit.

Each sensor has a centrifugal-force tripswitch

that does not enable transmission of the measured values until the motorcycle has accelerated to about 30 km/h. The display shows – – for each tyre until the tyre-pressure signal is received for the first time. The sensors continue to transmit the measured-value signals for approximately 15 minutes after the motorcycle comes to a stop.

The control unit can administrate four sensors, so two different sets of wheels with RDC sensors can be alternated on the motorcycle. An error message is issued if wheels without sensors are fitted to a motorcycle equipped with an RDC control unit.

Temperature compensation

The tyre-pressure readings shown by the multifunction display are temperature-compensated; the reference tyre temperature for these readings is always 20 °C.

The air lines available to the public in petrol stations and motorway service areas almost invariably show temperature-dependent tyre pressures, so in most instances these gauge readings will not tally with the readings shown by the multifunction display.

Tyre-pressure ranges

The RDC control unit differentiates between three air-pressure ranges, all of which are parameterised for the motorcycle:

- Air pressure within permitted tolerance.
- Air pressure close to limit of permitted tolerance.
- Air pressure outside permitted tolerance.

Brake system, general Descending mountain passes

 There is a danger of the brakes fading if you use only the rear brakes when descending mountain passes. Under extreme conditions, the brakes could overheat and suffer severe damage. Use both front and rear brakes, and make use of the engine's braking effect as well. ◀

Wet brakes

 After the motorcycle has been washed, ridden through water or ridden in the rain, the brake discs and pads might be wet and the brakes might not take effect immediately.

Apply the brakes in good time until the brakes have dried out. ◀

Salt on brakes

 The brakes may fail to take effect immediately if the motorcycle was ridden on salt-covered roads and the brakes were not applied for some time.

Apply the brakes in good time until the salt layer on the brake discs and brake pads has been removed. ◀

Oil or grease on brakes

 Oil and grease on the brake discs and pads considerably diminish braking efficiency.

Especially after repair and maintenance work, make sure that the brake discs and brake pads are free of oil and grease. ◀

Dirt or mud on brakes

 When riding on loose surfaces or muddy roads, the brakes may fail to take effect immediately because of dirt or moisture on the discs or brake pads.

Apply the brakes in good time until the brakes have been cleaned. ◀

Brake system with BMW Motorrad ABS^{OE}

Partially integral brakes

Your motorcycle is equipped with partially integral brakes. Both front and rear brakes are applied when you pull the handbrake lever. The foot-brake lever acts only on the rear brake.

When actively intervening in the braking process, the BMW Motorrad ABS adapts braking-force distribution between front and rear brakes to suit the load on the motorcycle.

 The integral braking function makes it very difficult to spin the rear wheel by opening the throttle with the front brake applied to keep the motorcycle stationary (burn-out).

Attempted burn-outs can result in damage to the rear brake and the clutch.

Do not attempt burn-outs. ◀

How does ABS work?

The amount of braking force that can be transferred to the road depends on factors that include the coefficient of friction of the road surface. Loose stones, ice and snow or a wet road all have much lower coefficients of friction than a clean, dry asphalt surface. The lower the coefficient of friction, the longer the braking distance.

If the rider increases braking pressure to the extent that braking force exceeds the maximum transferrable limit, the wheels start to lock and the motorcycle loses its directional stability; a fall is imminent. Before this situation

can occur, ABS intervenes and adapts braking pressure to the maximum transferrable braking force, so the wheels continue to turn and directional stability is maintained irrespective of the condition of the road surface.

What are the effects of surface irregularities?

Humps and surface irregularities can cause the wheels to lose contact temporarily with the road surface; if this happens the braking force that can be transmitted to the road can drop to zero. If the brakes are applied under these circumstances the ABS has to reduce braking force to ensure that directional stability is maintained when the wheels regain contact with the road surface. At this instant the BMW Motorrad ABS

must assume an extremely low coefficient of friction, so that the wheels will continue to rotate under all imaginable circumstances, because this is the precondition for ensuring directional stability. As soon as it registers the actual circumstances, the system reacts instantly and adjusts braking force accordingly to achieve optimum braking.

What feedback does the rider receive from the BMW Motorrad ABS?

If the ABS system has to reduce braking force on account of the circumstances described above, vibration is perceptible through the handbrake lever.

When the handbrake lever is pulled, brake pressure is also built up at the rear wheel by the integral function. If the

brake pedal is depressed after the handbrake lever is pulled, the brake pressure built up beforehand is perceptible as counter-pressure sooner than is the case when the brake pedal is depressed either before or at the same time as the brake lever is pulled.

How can stopping distance be minimised?

Each time the brakes are applied, a load distribution shift takes place with the load shifting forward from the rear to the front wheel. The sharper the motorcycle decelerates, the more load is shifted to the front wheel. The higher the wheel load, the more braking force can be transmitted without the wheel locking.

To optimise stopping distance, apply the front brakes rapidly and keep on increasing the force you apply to the brake lever. This makes the best possible use of the dynamic increase in load at the front wheel. Remember to pull the clutch at the same time. In the "panic braking situations" that are trained so frequently braking force is applied as rapidly as possible and with the rider's full force applied to the brake levers; under these circumstances the dynamic shift in load distribution cannot keep pace with the increase in deceleration and the tyres cannot transmit the full braking force to the surface of the road. ABS has to intervene to keep the front wheel from locking; this increases stopping distance.

Rear wheel lift

Even under severe braking, a high level of tyre grip can mean that the front wheel does not lock up until very late, if at all. Consequently, ABS does not intervene until very late, if at all. Under these circumstances the rear wheel can lift off the ground, and the outcome can be a highside situation in which the motorcycle can flip over.



Severe braking can cause the rear wheel to lift off the ground.

When you brake, bear in mind that ABS control cannot be relied on in all circumstances to prevent the rear wheel from lifting clear of the ground. ◀

What is the design baseline for BMW Motorrad ABS?

Within the limits imposed by physics, BMW Motorrad ABS ensures directional stability on any surface. The system is not optimised for special requirements that apply under extreme competitive situations off-road or on the track.

Special situations

The speeds of the front and rear wheels are compared as one means of detecting a wheel's incipient tendency to lock. If the system registers implausible values for a lengthy period the ABS function is deactivated for safety reasons and an ABS fault message is issued. Self-diagnosis has

to complete before fault messages can be issued. In addition to problems with the BMW Motorrad ABS, exceptional riding conditions can lead to a fault message being issued.

Exceptional riding conditions:

- Heating up with the motorcycle on the centre stand or an auxiliary stand, engine idling or with a gear engaged.
- Rear wheel locked by the engine brake for a lengthy period, for example while descending off-road.

If a fault message is issued on account of exceptional riding conditions as outlined above, you can reactivate the ABS function by switching the ignition off and on again.

What significance devolves on regular maintenance?



Invariably, a technical system cannot perform beyond the abilities dictated by its level of maintenance. In order to ensure that the BMW Motorrad ABS is always maintained in optimum condition, it is essential for you to comply strictly with the specified inspection intervals. ◀

Reserves for safety

The potentially shorter braking distances which BMW Motorrad ABS permits must not be used as an excuse for careless riding. ABS is primarily a means of ensuring a safety margin in genuine emergencies.

Take care when cornering. When you apply the brakes

on a corner, the motorcycle's weight and momentum take over and even BMW Motorrad ABS is unable to counteract their effects.

Accessories

General instructions	82
Power socket	82
Luggage	83
Case ^{OA}	83

General instructions

BMW Motorrad recommends the use of parts and accessories for your motorcycle that are approved by BMW for this purpose.

Genuine BMW parts and accessories and other products which BMW has approved can be obtained from your authorised BMW Motorrad dealer, together with expert advice on their installation and use.

These parts and products have been tested by BMW for safety, function and suitability. BMW accepts product liability for them.

Conversely, BMW is unable to accept any liability whatsoever for parts and accessories which it has not approved.



BMW Motorrad cannot assess each non-BMW product to determine whether it can be used on or in connection with BMW motorcycles without constituting a safety hazard. Country-specific official authorisation does not suffice as assurance. Tests conducted by these instances cannot make provision for all operating conditions experienced by BMW motorcycles and, consequently, they are not sufficient in some circumstances. Use only parts and accessories approved by BMW for your motorcycle. ◀

Whenever you are planning modifications, comply with all the legal requirements. Make sure that the motorcycle does not infringe national road-vehicle construction and use regulations.

Power socket Ratings

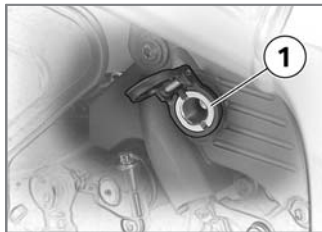

The supply to standard socket **1** and the extra socket (OE) is cut off automatically if battery voltage is low or the load exceeds the maximum for the two sockets.

Operating electrical accessories

You can start using electrical accessories only when the ignition is switched on. The accessory remains operational if the ignition is subsequently

switched off. In order to ensure that the drain on the on-board power supply system is minimised, the supply to the power socket is cut off approximately 15 minutes after the ignition is switched off, and it is also temporarily interrupted during the start procedure.

Cable routing

The cables from the power socket to the auxiliary device must be routed in such a way that they:

- Do not impede the rider
- Do not restrict or obstruct the steering angle and handling characteristics
- Cannot be trapped



Incorrectly routed cables can impede the rider.

Route the cables as described above. ◀

Luggage

Correct loading



Overloading and imbalanced loads can adversely affect the motorcycle's handling.

Do not exceed the permissible gross weight and be sure to comply with the instructions on loading. ◀

The maximum speed recommended for riding with loaded cases is 180 km/h.

- Set spring preload, damping characteristic and tyre pressures to suit total weight.
- Ensure that the case volumes on the left and right are equal.
- Make sure that the weight is uniformly distributed between right and left.

- Pack heavy items at the bottom and toward the in-board side.
- Max. load in each case (left and right): 8 kg.
- Max. load in tank rucksack 5 kg.

Case^{OA}

Release levers

Each case has two levers, one on each side of the lock. The grey lever marked OPEN is for opening and closing the case.

The black lever marked RELEASE is for removing and attaching the case.

Opening cases



- Turn the lock barrel in the OPEN direction.

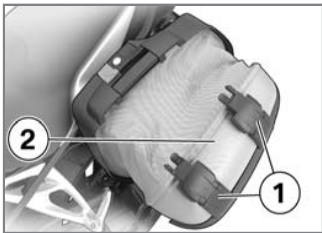

- Pull the grey release lever (OPEN) up.
 - » Lock straps **1** open.

- Pull the grey release lever (OPEN) up again.
- Pull case lid **2** out of the retainer.

Closing cases

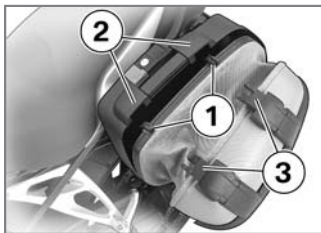

- Press catches **1** of the case lid into retainers **2**.
 - » The catches engage with an audible click.
- Press catches **3** on the lock straps into retainers **2**.
 - » The catches engage with an audible click.
- Check that the catches are locked securely into place.

Adjusting case volume

- Close the case lid.

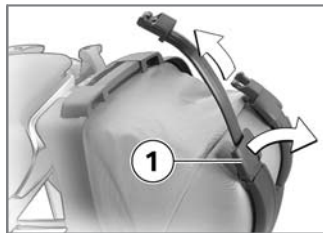

- Turn the lock strap buckles **1** of the lock straps out.
- Pull the lock straps up and out.
 - » This expands the case to maximum volume.

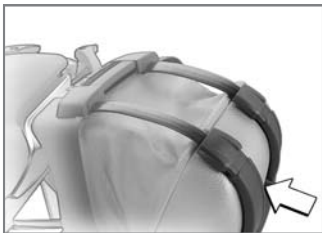

Removing cases

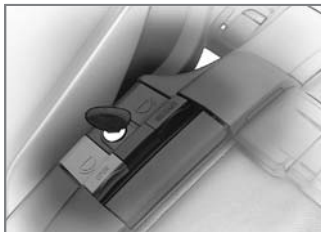

- Turn the lock barrel in the RELEASE direction.
- Pull the black release lever (RELEASE) up.

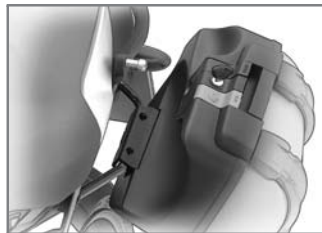

- Pull the case out of the top holder.
- Lift the case out of the bottom holder.

- Close the lock straps.
- Press the lock straps against the case body.
- » The case volume adapts to the contents.

Installing case

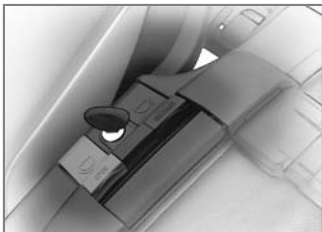

- Turn the lock barrel in the RELEASE direction.

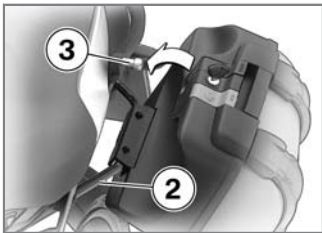

- Hook the case into bottom holder **2**.

- Pull the black release lever (RELEASE) up.
- Press the case into top holder **3**.
- Push the black release lever (RELEASE) down.
 - » The case is locked into place.
- Lock the case.
- Check that it is correctly engaged.

Secure attachment



If a case wobbles or is difficult to fit, it has to be adapted to the gap between the upper and lower mounting. The bot-

tom bracket on the case can be moved up or down for this purpose.

Adapting case

- Open the case.

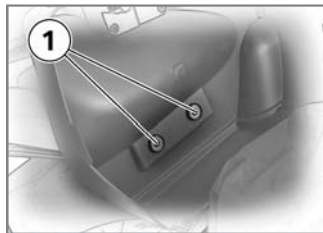

- Remove screws **1**.
- Adjust the height of the holder.
- Tighten screws **1**.

Maintenance

General instructions	88
Toolkit	88
Engine oil	89
Brake system, general	91
Brake pads.....	92
Brake fluid	94
Clutch	96
Tyres	97
Rims.....	97
Wheels	97
Front-wheel stand	105
Rear-wheel stand	107
Bulbs	108
Jump starting	116
Battery.....	117

General instructions

The 'Maintenance' chapter describes work involving the replacement of wear parts that can be performed with minimum effort.

Special tightening torques are listed as applicable.

If you are interested in information on more extensive work, we recommend the repair manual on CD-ROM which applies to your particular motorcycle. You can obtain a copy from your authorised BMW Motorrad dealer.

Some of the work calls for special tools and a thorough knowledge of motorcycles. If you are in doubt consult a specialist workshop, preferably your authorised BMW Motorrad dealer.

Toolkit

Standard on-board toolkit

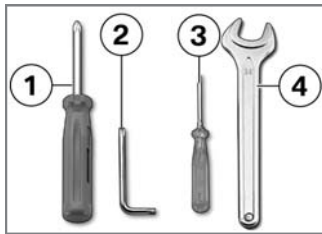

1 Screwdriver with reversible blade

- Removing and installing turn indicator glass
- Disconnecting leads from battery terminals

2 Torx wrench, T25

- Removing and installing body panels
- Removing and installing battery retainer

3 Screwdriver, small

- Removing and installing turn indicator glass

4 Open-ended spanner, w/f 14

- Adjusting mirror arm

On-board toolkit service kit

Your authorised BMW Motorrad dealer can provide the on-board toolkit service kit that you will need if you are considering undertaking more extensive work.

You will find information on undertaking work of this nature in the Repair Manual on the CD-ROM also obtainable from your authorised BMW Motorrad dealer.

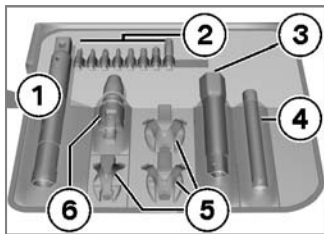

1 Extending tool holder

- Adapters to accommodate all tools

2 1/4" bits

- 5x Torx bits
- 2x cross-head bits
- 1x plain screwdriver bit

3 3/8" adapter for socket-head screws, w/f 22

- Removing and installing front wheel

4 Electric torch

- LED bulb

5 Socket

- 3x open-ended spanners, various sizes

6 Bit adapter

- Adapter for 1/4" bits
- 9x12 mm and 3/8" swivel adapters

Engine oil

Checking engine oil level



The engine can seize if the oil level is low, and this can lead to accidents. Always make sure that the oil level is correct. ◀



Oil can collect in the sump if the motorcycle is out of use for an extended period of time; this oil has to be pumped into the oil tank before the level is read. The engine oil must be at operating temperature to do this. Checking the oil level with the

engine cold or after no more than a short ride will lead to misinterpretation; this in turn, means that the engine will be operated with the incorrect quantity of oil.

In order to ensure that the engine oil level is read correctly, check the oil level only after a lengthy trip. ◀



The oil level varies with the temperature of the oil. The higher the temperature the higher the oil level in the oil tank. Check the engine oil level immediately after a lengthy journey. ◀

- Make sure the engine is at operating temperature and hold the motorcycle upright. with OA Centre stand:
- Check that the engine is at operating temperature, make sure the ground is level and firm and place

the motorcycle on its centre stand.◀

- Allow the engine to idle for one minute.
- Switch off the ignition.

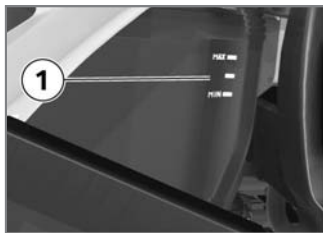

- Check the oil level in oil-level indicator **1**.



Engine oil, specified level

– Between MIN and MAX marks

If the oil level is below the MIN mark:

- Top up the engine oil.

If the oil level is above the MAX mark:

- Drain off the engine oil.

Top up the engine oil

- Make sure the ground is level and firm and place the motorcycle on its stand.
- Removing the seat (➡ 55)



Damage to the engine can result if it is operated without enough oil, but the same also applies if the oil level is too high. Always make sure that the oil level is correct.◀

- Wipe the area around the filler neck clean.

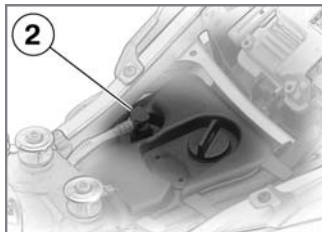
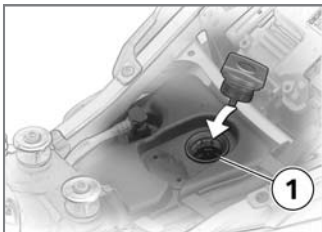

- Remove oil filler cap **1** by turning it counter-clockwise.
- Top up the engine oil to the specified level.
- Install cap of oil filler neck **1** and turn it clockwise to close.
- Installing the seat (➔ 56)

Draining engine oil

- Removing the seat (➔ 55)

- Squeeze the retainer of transparent tube **2** together on left and right and pull the tube up and out of the oil tank.
- Pull the transparent tube down out of the frame and drain the engine oil into a suitable container until the level is to specification.
- Insert the transparent tube into the oil tank and engage the retainer.
- Store or dispose of the excess engine oil in an environmentally compatible manner.

- Installing the seat (➔ 56)

Brake system, general Reliability

A fully functional brake system is a basic requirement for the road safety of your motorcycle.

Do not ride the motorcycle if you have any doubts about the dependability of the brake system.

Under these circumstances have the brake system checked by a specialist workshop, preferably an authorised BMW Motorrad dealer.



Incorrect working practices endanger the reliability of the brakes.

Have all work on the brake system performed by a specialist workshop, preferably

an authorised BMW Motorrad dealer. ◀

Check operation of the brakes

- Pull the handbrake lever.
 - » The pressure point must be clearly perceptible.
- Press the footbrake lever.
 - » The pressure point must be clearly perceptible.

Brake pads

Checking brake-pad thickness, front brakes



Brake pads worn past the minimum permissible thickness can cause a reduction in braking efficiency and under certain circumstances they can cause damage to the brake system.

In order to ensure the dependability of the brake system, do not permit the brake

pads to wear past the minimum permissible thickness. ◀

- Make sure the ground is level and firm and place the motorcycle on its stand.



- Visually inspect the left and right brake pads to ascertain their thickness.

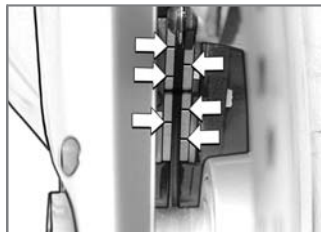

Brake-pad thickness, front

- The wear indicators on the brake pads must be clearly visible.

If the wear indicating mark is no longer clearly visible:

- Have the brake pads replaced by a specialist workshop, preferably an authorised BMW Motorrad dealer.

Checking brake pad thickness, rear brakes

 Brake pads worn past the minimum permissible thickness can cause a reduction in braking efficiency and under certain circumstances they can cause damage to the brake system.

In order to ensure the dependability of the brake system, do not permit the brake pads to wear past the minimum permissible thickness. ◀

- Make sure the ground is level and firm and place the motorcycle on its stand.

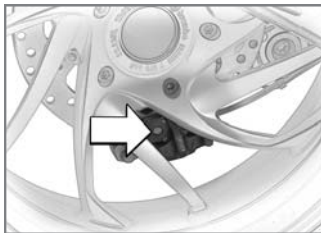

- Visually inspect the brake pads from the right to ascertain their thickness.



Brake-pad wear limit, rear

– 1 mm (Friction pad only, without backing plate)

– Make sure that the brake disc is not visible through the bore in the inboard brake block.

If the brake disc is visible:

- Have the brake pads replaced by a specialist workshop, preferably an authorised BMW Motorrad dealer.

Brake fluid

Check the brake-fluid level, front brakes

 A low fluid level in the brake reservoir can allow air to penetrate the brake system. This significantly reduces braking efficiency. Check the brake-fluid level at regular intervals.◀

- Make sure the ground is level and firm and hold the motorcycle upright.
- Move the handlebars to the straight-ahead position.
with OA Centre stand:
- Make sure the ground is level and firm and place the motorcycle on its centre stand.
- Move the handlebars to the straight-ahead position.<



- Check the brake fluid level in front reservoir **1**.

 The brake fluid level in the brake fluid reservoir drops as the brake pads wear.◀



Brake fluid level, front

– DOT4 brake fluid

– Do not permit the brake fluid level to drop below the MIN mark. (Brake-fluid reservoir horizontal)

If the brake fluid level drops below the permitted level:

- Have the defect rectified as quickly as possible by a specialist workshop, preferably an authorised BMW Motorrad dealer.

Check the brake-fluid level, rear brakes



A low fluid level in the brake reservoir can allow air to penetrate the brake system. This significantly reduces braking efficiency. Check the brake-fluid level at regular intervals. ◀

- Make sure the ground is level and firm and hold the motorcycle upright with OA Centre stand:
- Make sure the ground is level and firm and place the motorcycle on its centre stand. ◁



- Check the brake fluid level in brake fluid reservoir **1**.

▷ The brake fluid level in the brake fluid reservoir drops as the brake pads wear. ◀

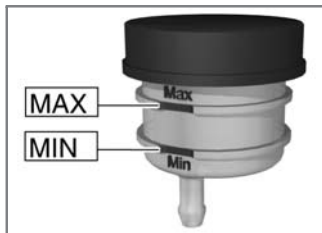

Brake fluid level, rear

– DOT4 brake fluid

– Do not permit the brake fluid level to drop below the MIN mark. (Brake-fluid reservoir horizontal)

If the brake fluid level drops below the permitted level:

- Have the defect rectified as quickly as possible by a specialist workshop, preferably an authorised BMW Motorrad dealer.

Clutch

Checking clutch operation

- Pull the clutch lever.
 - » The pressure point must be clearly perceptible.
- If the pressure point is not clearly perceptible:
- Have the clutch checked by a specialist workshop, preferably an authorised BMW Motorrad dealer.

Check the clutch fluid level

- Make sure the ground is level and firm and hold the motorcycle upright.
 - Move the handlebars to the straight-ahead position.
- with OA Centre stand:
- Make sure the ground is level and firm and place

the motorcycle on its centre stand.

- Move the handlebars to the straight-ahead position.◀



- Check the clutch fluid level in clutch fluid reservoir 1.

▶ Wear of the clutch causes the fluid level in the clutch fluid reservoir to rise.◀



Clutch fluid level

- Do not permit the clutch fluid level to drop.

If the fluid level drops:



Unsuitable hydraulic fluids could cause damage to the clutch system.

Do not attempt to top up the system with fluids of any kind.◀

- Have the defect rectified as quickly as possible by a specialist workshop, prefer-

ably an authorised BMW Motorrad dealer.

 The clutch system is filled with a special hydraulic fluid that does not have to be changed.◀

Tyres

Check the tyre tread depth

 Your motorcycle's handling and grip can be impaired even before the tyres wear to the minimum tyre tread depth permitted by law. Have the tyres changed in good time before they wear to the minimum permissible tread depth.◀

- Make sure the ground is level and firm and place the motorcycle on its stand.

- Measure the tyre tread depth in the main tread grooves with wear marks.

 Tyres have wear indicators integrated into the main tread grooves. The tyre is worn out when the tyre tread has worn down to the level of the marks. The locations of the marks are indicated on the edge of the tyre, e.g. by the letters TI, TWI or by an arrow.◀

If the tyre tread is worn to minimum:

- Replace tyre or tyres, as applicable.

Rims

Checking rims

- Make sure the ground is level and firm and place the motorcycle on its stand.

- Visually inspect the rims for defects.
- Have damaged rims checked and, if necessary, replaced by a specialist workshop, preferably an authorised BMW Motorrad dealer.

Wheels

Recommended tyres

For each size of tyre BMW Motorrad tests and classifies as roadworthy certain makes. BMW Motorrad cannot assess the suitability or provide any guarantee of road safety for other tyres.

BMW Motorrad recommends using only tyres tested by BMW Motorrad.

You can obtain detailed information from your authorised BMW Motorrad dealer or

on the Internet at www.bmw-motorrad.com.

RDC label^{OE}

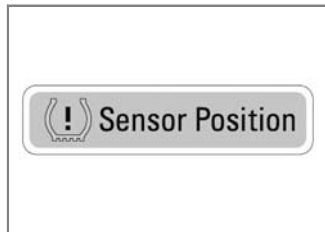

! Incorrect tyre-removal procedures can result in damage to the RDC sensors. Be sure to notify the authorised BMW Motorrad dealer or specialist workshop that the wheel is fitted with an RDC sensor. ◀

If the motorcycle is equipped with RDC, each wheel rim bears an adhesive label indicating the position of the RDC

sensor. When changing the tyre, take care not to damage the RDC sensor. Be sure to draw the attention of the authorised BMW Motorrad dealer or specialist workshop to the fact that the wheel is fitted with an RDC sensor.

Removing front wheel

- Place the motorcycle on an auxiliary stand; BMW Motorrad recommends the BMW Motorrad rear-wheel stand.
- Install the rear-wheel stand (➔ 107) with OA Centre stand:
- Make sure the ground is level and firm and place the motorcycle on its centre stand. ◀



- !** Once the calipers have been removed, there is a risk of the brake pads being pressed together to the extent that they cannot be slipped back over the brake disc on reassembly. Do not operate the handbrake lever when the brake calipers have been removed. ◀
- Remove securing screws **1** of the brake calipers on left and right.

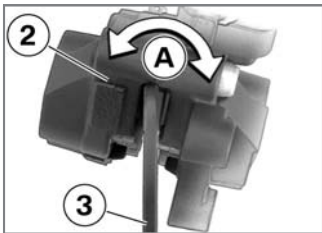

- Force the brake pads slightly apart by rocking brake calipers **2** back and forth **A** against brake discs **3**.
- Mask off the parts of the wheel rim that could be scratched in the process of removing the brake calipers.
- Carefully pull the brake calipers back and out until clear of the brake discs.

with OE BMW Motorrad Integral ABS:

- When removing the left brake caliper, take care not

to damage the ABS sensor cable.◀

- Raise the front of the motorcycle until the front wheel can rotate freely. BMW Motorrad recommends the BMW Motorrad front wheel stand for lifting the motorcycle.
- Fitting the front wheel stand (➡ 105)

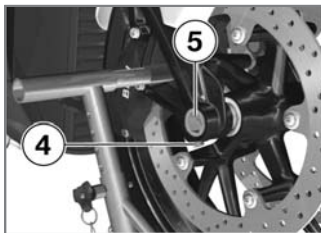

- Remove right-hand axle clamping screw **4**.

with OE BMW Motorrad Integral ABS:

 The left axle clamping screw locates the threaded bush in the front suspension. If the threaded bush is not correctly aligned the gap between the ABS sensor ring and the ABS sensor will not be correct and this can cause the ABS to malfunction or allow the ABS sensor to be damaged. In order to ensure that the threaded bush remains correctly aligned, do not slacken or remove the left axle clamping screw.◀

- Remove right-hand axle clamping screw **4**.◀
- Remove quick-release axle **5**, holding the wheel as you do so.

- Lower the front wheel to the ground between the front forks.

- Roll the front wheel forward to remove.

with OE BMW Motorrad Integral ABS:

 Take care not to damage the ABS sensor when rolling out the front wheel. Note the ABS sensor when rolling out the front wheel. ◀

- Roll the front wheel forward to remove. ◀

Installing front wheel

 ABS malfunctions on account of incorrect speed signal.

Segmentation differs between individual types of sensor ring; it is very important to ensure that the correct sensor ring is installed. Install only the sensor ring that matches

the motorcycle's construction status. ◀

 Threaded fasteners not tightened to the specified torque can work loose or their threads can suffer damage.

Always have the security of the fasteners checked by a specialist workshop, preferably an authorised BMW Motorrad dealer. ◀

 The front wheel must be installed right way round to rotate in the correct direction.

Note the direction-of-rotation arrows on the tyre or the wheel rim. ◀

- Roll the front wheel into position between the front forks.

with OE BMW Motorrad Integral ABS:

 There is a risk of damaging parts of the front brake, particularly the BMW Motorrad Integral ABS, in the course of the procedure described below.

Take care not to damage the brake system, in particular the ABS sensor with cable and the ABS sensor ring. ◀

 Take care not to damage the ABS sensor when rolling in the front wheel. Note the ABS sensor when rolling in the front wheel. ◀

- Roll the front wheel into position between the front forks. ◀

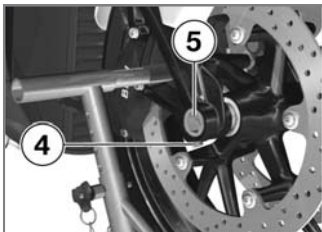

- Raise the front wheel, insert quick-release axle **5** and tighten to specified torque.

 Quick-release axle in threaded bush

– 50 Nm

- Tighten right axle clamping screw **4** to the specified tightening torque.

 Clamping screw for quick-release axle in wheel carrier

– 19 Nm

- Remove the front wheel stand.
- Ease the brake calipers on to the brake discs. with OE BMW Motorrad Integral ABS:

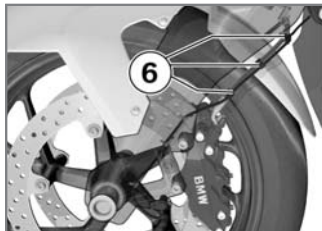

 The cable of the ABS sensor could chafe through if it comes into contact with the brake disc. Make sure that the ABS sensor cable is routed correctly. ◀

- Carefully route the ABS cable. Make sure that the

ABS sensor cable is clipped into holders **6**. ◀



- Install securing screws **1**.

 Front brake caliper to wheel carrier

– 30 Nm

- Remove the adhesive tape from the wheel rim.
- Firmly pull the handbrake lever until the pressure point is perceptible, and repeat this operation several times.

Removing rear wheel

- Place the motorcycle on an auxiliary stand; BMW Motorrad recommends the BMW Motorrad rear-wheel stand.
 - Install the rear-wheel stand (➔ 107)
- with OA Centre stand:
- Make sure the ground is level and firm and place the motorcycle on its centre stand.◁

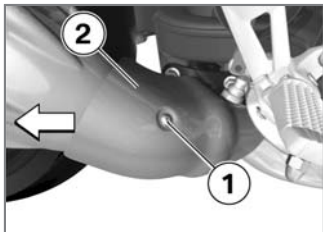

- Remove screw **1** from silencer cover **2**.

- Pull the cover to the rear to remove.

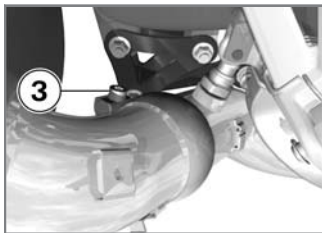

- Remove clamp **3** from the silencer.
- Do not remove the sealing grease from the clamp.

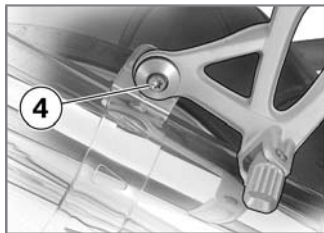

- Remove screw **4** for the bracket of the end silencer from the rear footrest.
- Turn the end silencer out.
- Engage first gear.



Installing rear wheel

 Threaded fasteners not tightened to the specified torque can work loose or their threads can suffer damage.

Always have the security of the fasteners checked by a specialist workshop, preferably an authorised BMW Motorrad dealer. ◀

- If you are using the BMW Motorrad rear-wheel stand: remove the retaining disc.
- Roll the rear wheel into position at the rear-wheel adapter.
- Seat the rear wheel on the rear-wheel adapter.
- If you are using the BMW Motorrad rear-wheel stand: reinstall the retaining disc.

- Remove studs **5** from the rear wheel, holding the wheel as you do so.
- If you are using the BMW Motorrad rear-wheel stand: remove the retaining disc.
- Lower the rear wheel to the ground.
- Roll the rear wheel out toward the rear.
- If you are using the BMW Motorrad rear-wheel stand: reinstall the retaining disc.



- Install wheel studs **5** and tighten to the specified torque in diagonally opposite sequence.

 Rear wheel to wheel flange

– Tightening sequence:
Tighten in diagonally opposite sequence

– 60 Nm

- Turn the end silencer to its initial position.



- Install screw **4** for the bracket of the end silencer in the rear footrest, but do not tighten it at this point.

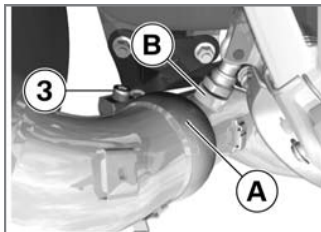

- Align clamp **3** on the end silencer with mark **A** (arrow) on oxygen sensor **B**.
- Tighten clamp **3** on the end silencer to the specified tightening torque.



Silencer to manifold

– 35 Nm



- ⚠ If the gap between the rear wheel and the end silencer is too small, the rear wheel can overheat. The clearance between the rear wheel and the end silencer must be at least 10 mm. ◀
- Tighten screw **4** for the bracket of the end silencer in the rear footrest to the specified torque.

Silencer to rear
footrest, right

– 22 Nm

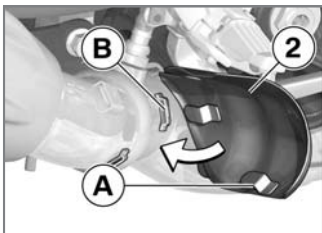

- Push silencer cover **2** with guides **A** into retainers **B**.

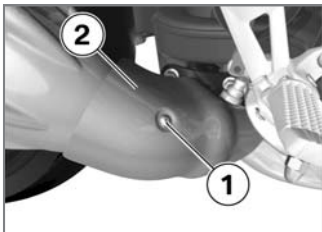

- Install screw **1** in silencer cover **2**.
- Remove the auxiliary stand, if installed.

Front-wheel stand

Front-wheel stand

A front wheel stand for simple, safe changing of the front wheel is available from BMW Motorrad. The BMW special tool number is 36 3 971 and the front-wheel stand is available from your authorised BMW Motorrad dealer. You also need the adapters with the BMW special tool number 36 3 973.

! The BMW Motorrad front wheel stand is not designed to support motorcycles not fitted with a centre stand or without other auxiliary stands. A motorcycle resting only on the front wheel stand and the rear wheel can topple.

Place the motorcycle on its centre stand or another auxiliary stand before lifting the

front wheel with the BMW Motorrad front-wheel stand. ◀

Fitting the front wheel stand

- Place the motorcycle on an auxiliary stand; BMW Motorrad recommends the BMW Motorrad rear-wheel stand.
- Install the rear-wheel stand (➔ 107) with OA Centre stand:
- Make sure the ground is level and firm and place the motorcycle on its centre stand. ◀



- Slacken adjusting screws **1**.
- Push the two pins **2** apart until the front suspension fits between them.
- Use locating pins **3** to set the front-wheel stand to the desired height.
- Centre the front-wheel stand relative to the front wheel and push it against the front axle.



- Push both mounting pins **2** through the triangles of the brake caliper anchorages just far enough to allow the front wheel to be rolled between them.
- ⚠** There is a risk of damaging the ABS sensor ring of the BMW ABS. Push the pin in just far enough to ensure that it clears the sensor ring of the BMW ABS. ◀
- Tighten adjusting screws **1**.



- ⚠** If the motorcycle is on the centre stand and is raised too far, the centre stand will lift clear of the ground and the motorcycle could topple to one side. When raising the motorcycle, make sure that the centre stand remains on the ground. ◀
- Apply uniform pressure to push the front-wheel stand down and raise the motorcycle.

Rear-wheel stand

Rear-wheel stand

BMW Motorrad offers a rear-wheel stand for holding motorcycles (including those without centre stands) securely upright for maintenance work. The BMW special tool number is 36 3 980 and the rear-wheel stand is available from your authorised BMW Motorrad dealer.

Installing rear-wheel stand

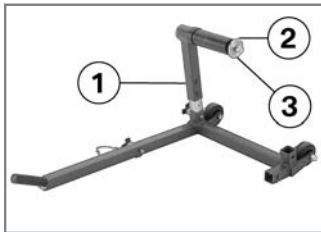

- Use screws **1** to set the rear-wheel stand to the desired height.
- Remove retaining disc **2**. To do so, press release button **3**.

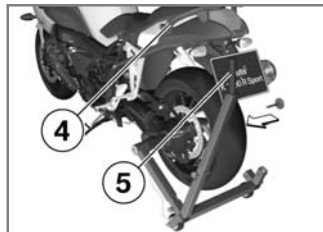

- Push the rear wheel stand from the left into the rear axle.
- Install the retaining disc from the right; to do so, press the unlock button.
- Place your left hand on the left grab handle of the motorcycle **4**, and your right hand on the lever of the rear wheel stand **5**.

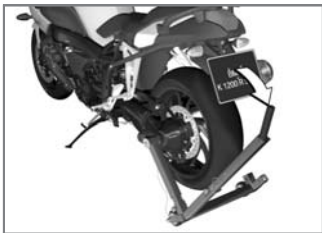

- Lift the motorcycle upright, simultaneously pressing the lever down until the stand supports the motorcycle in the upright position.



- Press the lever down to the ground.

Bulbs

General instructions

The 'bulb defect' symbol appears in the display if a bulb is defective. If the brake or rear light fails, the symbol is accompanied by the general warning light, which lights up yellow. If the rear light fails the second filament of the brake light shines at reduced brightness to double as a rear light. Even though you have

this substitute rear light, the indicators in the display tell you that a bulb defect has occurred.



A defective bulb places your safety at risk because it is easier for other users to oversee you and your motorcycle.

Replace defective bulbs as soon as possible; always carry a complete set of spare bulbs if possible. ◀



The bulb is pressurised and can cause injury if damaged.

Wear protective goggles and gloves when changing bulbs. ◀



The types of bulb fitted to your motorcycle are listed in the section entitled "Technical data". ◀

▷ Do not touch the glass of new bulbs with your fingers. Use a clean, dry cloth to hold the bulbs when handling them. Dirt deposits, in particular oil and grease, interfere with heat radiation from the bulb. This leads to overheating and shortens the bulb's operating life.◀

Replacing low-beam and high-beam headlight bulb

⚠ If it is not standing firmly, the motorcycle could topple in the course of the operations described below. Always make sure that the motorcycle is stable and firmly supported.◀

▷ Turn the handlebars to the left to facilitate access.◀

- Make sure the ground is level and firm and place the motorcycle on its stand.
- Switch off the ignition.

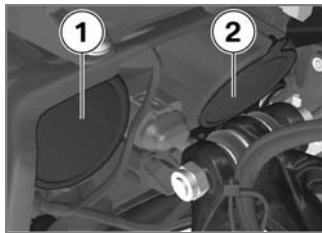

- Remove cover 1 (low-beam headlight) or cover 2 (high-beam headlight) by pulling lever.

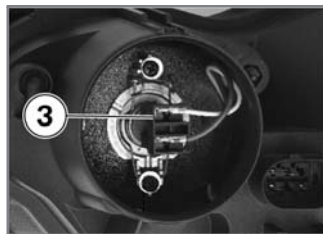

- Disconnect plug 3.

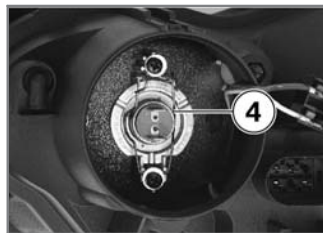

- Disengage spring clips 4 from the fastenings and swing them aside.

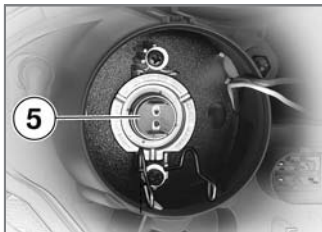

- Remove bulb **5**.
- Replace the defective bulb.



High-beam headlight
bulb

- H7 / 12 V / 55 W



Low-beam headlight
bulb

- H7 / 12 V / 55 W



- Insert the bulb; make sure that projection **6** is correctly positioned (high-beam headlight down / low-beam headlight up) and make check that the bulb engages correctly.

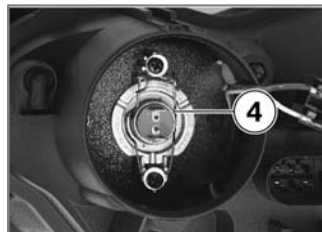

- Close and lock spring clips **4**.

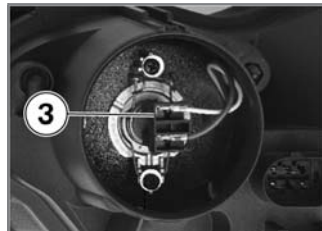

- Connect plug **3**.

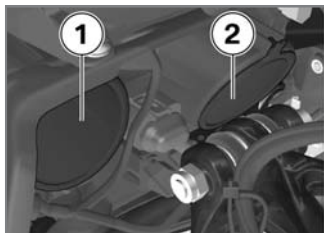

- Install cover **1** (low-beam headlight) or cover **2** (high-beam headlight).

Replacing parking-light bulb

 If it is not standing firmly, the motorcycle could topple in the course of the operations described below. Always make sure that the motorcycle is stable and firmly supported.◀

- Make sure the ground is level and firm and place the motorcycle on its stand.

- Switch off the ignition.
-  Turn the handlebars to the left to facilitate access.◀

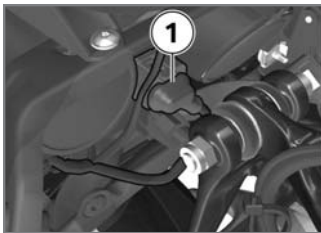

- Remove cap **1**.

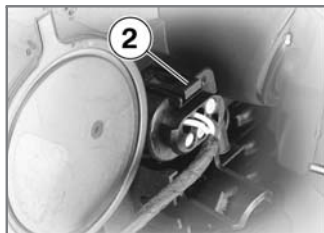

- Disconnect plug **2**.



- Turn bulb socket **3** counter-clockwise to remove.

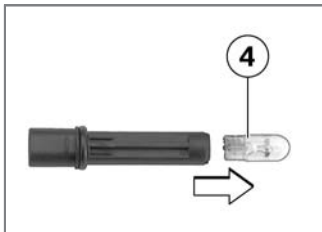

- Remove bulb **4** from the bulb holder.
- Replace the defective bulb.



Parking-light bulb

– W5W / 12 V / 5 W

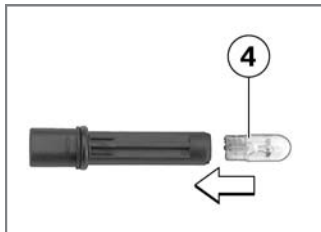

- Push bulb **4** into its socket.



- Turn bulb socket **3** clock-wise to install.

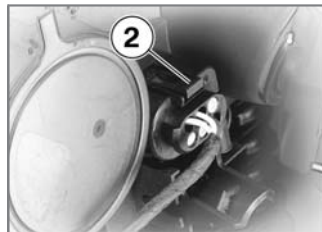

- Connect plug **2**.



- Install cap **1**.

Replacing brake light and rear light bulb

 If it is not standing firmly, the motorcycle could topple in the course of the operations described below. Always make sure that the motorcycle is stable and firmly supported. ◀

- Make sure the ground is level and firm and place the motorcycle on its stand.
- Removing the seat (➔ 55)
- Switch off the ignition.

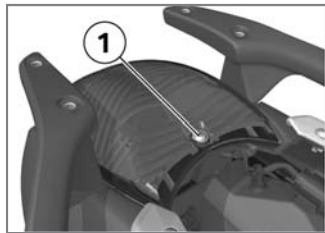

- Remove screw **1**.

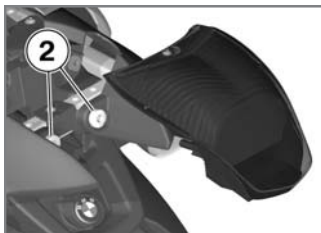

- Pull the bulb housing to the rear until it is clear of holders **2**.



- Turn bulb holder **3** counter-clockwise to remove it from the bulb housing.

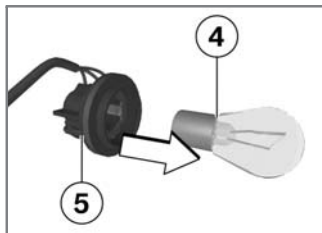

- Press bulb **4** into socket **5** and remove by turning it counter-clockwise.
- Replace the defective bulb.

 Bulb of tail light/brake light

- P21W / 12 V / 21 W

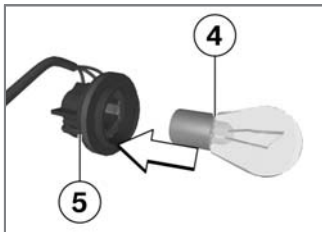

- Press bulb **4** into socket **5** and turn it clockwise to install.



- Turn bulb socket **3** clockwise to install it in the bulb housing.

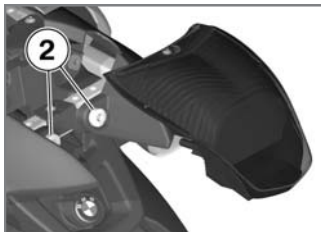

- Seat the bulb housing in holders **2**.

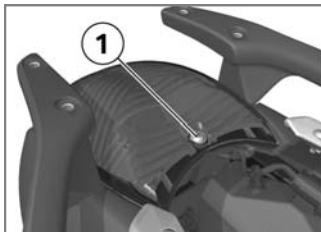

- Install screw **1**.

Replacing turn indicator bulbs, front and rear

⚠ If it is not standing firmly, the motorcycle could topple in the course of the operations described below. Always make sure that the motorcycle is stable and firmly supported. ◀

- Make sure the ground is level and firm and place the motorcycle on its stand.
- Switch off the ignition.



- Remove screw **1**.

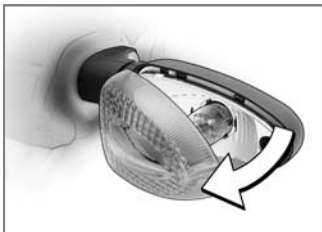

- Pull the turn indicator glass out of the turn indicator housing at the threaded-fastener side.

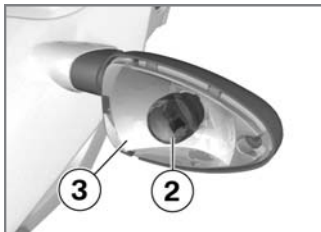

- Press bulb **2** into fitting **3** and remove by turning it counter-clockwise.
- Replace the defective bulb.



Front flashing turn indicator bulbs

– R10W / 12 V / 10 W

with OE White turn indicators:

– RY10W / 12 V / 10 W◁



Rear flashing turn indicator bulbs

– R10W / 12 V / 10 W



Rear flashing turn indicator bulbs

with OE White turn indicators:

– RY10W / 12 V / 10 W◁

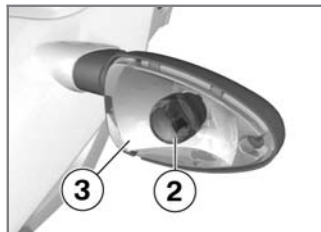

- Turn bulb **2** clockwise to install it in bulb socket **3**.

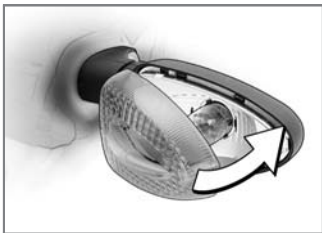

- Position the bulb housing on the turn indicator housing.



- Install screw 1.

Jump starting

! The wires leading to the power socket do not have a load-capacity rating adequate for jump-starting the engine. Excessively high current can lead to a cable fire or damage to the vehicle electronics.

Do not use the on-board socket to jump-start the engine of the motorcycle. ◀

! Touching live parts of the ignition system with the engine running can cause electric shock.

Do not touch parts of the ignition system when the engine is running. ◀

! A short-circuit can result if the crocodile clips of the jump leads are accidentally brought into contact with the motorcycle.

Use only jump leads fitted

with fully insulated crocodile clips at both ends. ◀

! Jump-starting with a donor-battery voltage higher than 12 V can damage the vehicle electronics. Make sure that the battery of the donor vehicle has a voltage rating of 12 V. ◀

! If it is not standing firmly, the motorcycle could topple in the course of the operations described below. Always make sure that the motorcycle is stable and firmly supported. ◀

- When jump-starting the engine, do not disconnect the battery from the on-board electrical system.
- Removing battery-compartment cover (➡ 119)

- Run the engine of the donor vehicle during jump-starting.
- Begin by connecting one end of the red jump lead to the positive terminal of the discharged battery and the other end to the positive terminal of the donor battery.
- Then connect one end of the black jump lead to the negative terminal of the donor battery, and the other end to the negative terminal of the discharged battery.
- Start the engine of the vehicle with the discharged battery in the usual way; if the engine does not start, wait a few minutes before repeating the attempt in order to protect the starter motor and the donor battery.
- Allow both engines to idle for a few minutes before

disconnecting the jump leads.

- Disconnect the jump lead from the negative terminals first, then disconnect the second lead from the positive terminals.
- Installing battery-compartment cover (➡ 119)

Battery

Maintenance instructions

Correct upkeep, recharging and storage will prolong the life of the battery and are essential if warranty claims are to be considered.

Compliance with the points below is important in order to maximise battery life:

- Keep the surface of the battery clean and dry
- Do not open the battery
- Do not top up with water

- Be sure to read and comply with the instructions for charging the battery on the following pages
- Do not turn the battery upside down



If the battery is not disconnected, the on-board electronics (e.g. clock, etc.) gradually drain the battery. This can cause the battery to run flat. If this happens, warranty claims will not be accepted.

If the motorcycle is to be out of use for more than four weeks, disconnect the battery or connect a suitable trickle charger to the battery. ◀



BMW Motorrad has developed a trickle-charger specially designed for compatibility with the electronics of your motorcycle. Using this charger, you can keep the

battery charged during long periods of disuse, without having to disconnect the battery from the motorcycle's on-board systems. You can obtain additional information from your authorised BMW Motorrad dealer.◀

Charging battery when connected

 Charging the connected battery directly at the battery terminals can damage the vehicle electronics.

Always disconnect the battery from the on-board circuits before recharging it with a charger connected directly to the battery posts.◀

 Only chargers suitable for this mode of charging can be used to recharge the battery via the on-board socket. Unsuitable chargers could

cause damage to the motorcycle's on-board electrics. Use BMW chargers with the part numbers 71 60 7 688 864 (220 V) or, as applicable, 71 60 7 688 865 (110 V). If you are in doubt, disconnect the battery from the on-board systems and connect the charger directly to the battery.◀

 If you switch on the ignition and the multifunction display and telltale lights fail to light up, the battery is completely flat. Attempting to charge a completely flat battery via the on-board socket can cause damage to the motorcycle's electronics.

If a battery has discharged to the extent that it is completely flat, it has to be disconnected from the on-board circuits and charged with the char-

ger connected directly to the battery posts.◀

- Charge via the power socket, with the battery connected to the motorcycle's on-board electrical system.

 The motorcycle's on-board electronics know when the battery is fully charged. The on-board socket is switched off when this happens.◀

- Comply with the operating instructions of the charger.

 If you are unable to charge the battery through the on-board socket, you may be using a charger that is not compatible with your motorcycle's electronics. If this happens, disconnect the battery from the on-board systems and connect the charger directly to the battery.◀

Charging battery when disconnected

- Charge the battery using a suitable charger.
- Comply with the operating instructions of the charger.
- Once the battery is fully charged, disconnect the charger terminal clips from the battery terminals.

▷ The battery has to be recharged at regular intervals in the course of a lengthy period of disuse. See the instructions for caring for your battery. Always fully recharge the battery before restoring it to use◀

Removing battery-compartment cover

⚠ If it is not standing firmly, the motorcycle could topple in the course of the operations described below.

Always make sure that the motorcycle is stable and firmly supported.◀

- Make sure the ground is level and firm and place the motorcycle on its stand.
- Removing the seat (➔ 55)

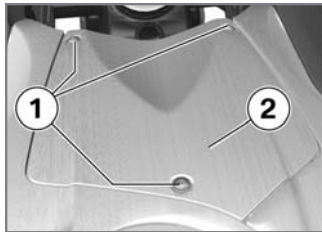

- Remove screws **1**.
- Lift battery compartment cover **2** up and forward to remove.

Installing battery-compartment cover

⚠ If it is not standing firmly, the motorcycle could topple in the course of the operations described below. Always make sure that the motorcycle is stable and firmly supported.◀

- Make sure the ground is level and firm and place the motorcycle on its stand.

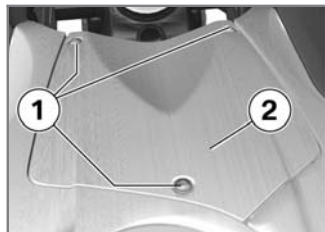

- Install battery compartment cover **2**.
- Install screws **1**.

- Installing the seat (➔ 56)

Removing battery

- Removing battery-compartment cover (➔ 119)

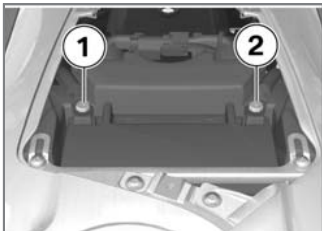

⚠ Disconnection in the wrong sequence increases the risk of short-circuits.

Always proceed in the correct sequence. ◀

- Disconnect negative battery lead **1** first.

- Then disconnect positive battery lead **2**.

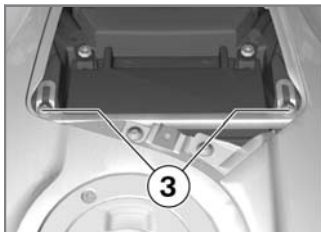

- Remove screws **3** and pull the retainer to the rear.
- Lift the battery up and out; work it slightly back and forth if it is difficult to remove.

Installing battery

- Switch off the ignition.
- Place the battery in the battery compartment, positive terminal on the right in the forward direction of travel.

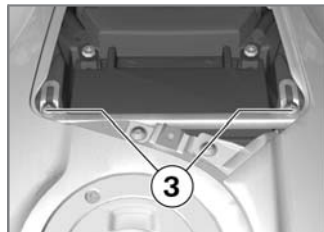

- Slip the battery retainer over the battery and install screws **3**.

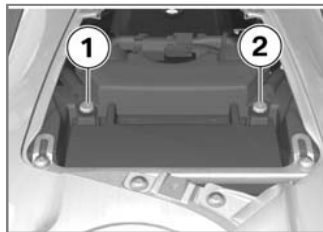

⚠ Installation in the wrong sequence increases the risk of short-circuits.

Always proceed in the correct sequence. ◀

- Connect battery positive lead **2** first.
- The connect battery negative lead **1**.
- Installing battery-compartment cover (➡ 119)
- Switch on the ignition.
- Fully open the throttle once or twice.
- » The engine management system registers the throttle-valve position.
- Set the clock (➡ 44)

Care

Care products	124
Washing motorcycle	124
Cleaning easily damaged components	125
Paint care	126
Protective wax coating	126
Laying up the motorcycle	126
Restoring motorcycle to use	127

Care products

We recommend that you use the cleaning and care products you can obtain from your authorised BMW Motorrad dealer. The substances in BMW Care Products have been tested in laboratories and in practice; they provide optimised care and protection for the materials used in your vehicle.

 The use of unsuitable cleaning and care products can damage vehicle components.

Do not use solvents such as cellulose thinners, cold cleaners, fuel or the like, and do not use cleaning products that contain alcohol. ◀

Washing motorcycle

We recommend that you use BMW insect remover to soften and wash off insects and resilient dirt on painted parts prior to washing the motorcycle.

To prevent stains, do not wash the motorcycle immediately after it has been exposed to strong sunlight and do not wash it in the sun. Make sure that the motorcycle is washed frequently, especially during the winter months.

To remove road salt, clean the motorcycle with cold water immediately after every trip.

 After the motorcycle has been washed, ridden through water or ridden in the rain, the brake discs and pads might be wet and the

brakes might not take effect immediately.

Apply the brakes in good time until the brakes have dried out. ◀

 Warm water intensifies the effect of salt.

Use only cold water to wash off road salt. ◀

 The high pressure of steam cleaners can damage seals, the hydraulic brake system, the electrical system, and the seat.

Do not use a steam jet or high-pressure cleaning equipment. ◀

Cleaning easily damaged components

Plastics

Clean plastic parts with water and BMW plastic care emulsion. This includes in particular:

- Windscreen
- Headlight lens made of plastic
- Glass cover of the instrument cluster
- Black, unpainted parts

 If plastic parts are cleaned using unsuitable cleaning agents, the surfaces can be damaged.

Do not use cleaning agents that contain alcohol, solvents or abrasives to clean plastic parts.

Even fly-remover pads or cleaning pads with hard

surfaces can produce scratches. ◀

 Soften stubborn dirt and insects by covering the affected areas with a wet cloth. ◀

Windscreen

Clean off dirt and insects with a soft sponge and plenty of water.

 Fuel and chemical solvents attack the material of the windscreen; the windscreen becomes opaque or dull. Do not use cleaning agents. ◀

Chrome

Use plenty of water and BMW shampoo to clean chrome, particularly if it has been exposed to road salt. Use chrome polish for additional treatment.

Radiator

Clean the radiator regularly to prevent overheating of the engine due to inadequate cooling.

For example, use a garden hose with low water pressure.

 Cooling fins can be bent easily.

Take care not to bend the fins when cleaning the radiator. ◀

Rubber

Treat rubber components with water or BMW rubber-care products.

 Using silicone sprays for the care of rubber seals can cause damage.

Do not use silicone sprays or other care products that contain silicon. ◀

Paint care

Washing the motorcycle regularly will help counteract the long-term effects of substances that damage the paint, especially if your motorcycle is ridden in areas with high air pollution or natural sources of dirt, for example tree resin or pollen.

Remove particularly aggressive substances immediately, however, as otherwise the paint can be affected or become discoloured. Substances of this nature include spilt fuel, oil, grease, brake fluid and bird droppings. We recommend BMW vehicle polish or BMW paint cleaner for this purpose.

Marks on the paintwork are particularly easy to see after the motorcycle has been washed. Remove stains of

this kind immediately, using cleaning-grade benzene or petroleum spirit on a clean cloth or ball of cotton wool. We recommend that specks of tar be removed with BMW tar remover. Remember to wax the parts treated in this way.

Protective wax coating

BMW Motorrad recommends applying only BMW car wax or products containing carnauba wax or synthetic wax.

It is time to rewax the paintwork when water "puddles" on the surface, instead of forming beads.

Laying up the motorcycle

- Clean the motorcycle.
- Remove the battery.

- Spray the brake and clutch lever pivots and the main and side stand pivots with a suitable lubricant.
- Coat bright metal and chrome-plated parts with an acid-free grease (e.g. Vaseline).
- Stand the motorcycle in a dry room in such a way that there is no load on either wheel.

▶ Before laying the vehicle up out of use, have the engine oil and the oil filter element changed by a specialist workshop, preferably an authorised BMW Motorrad dealer. Combine work for laying up/restoring to use with a BMW service or inspection.◀

Restoring motorcycle to use

- Remove the protective wax coating.
- Clean the motorcycle.
- Install a charged battery.
- Before starting: work through the checklist.

Technical data

Troubleshooting chart	130
Threaded fasteners	131
Engine	133
Performance figures	135
Clutch	135
Transmission	135
Rear-wheel drive	136
Running gear	137
Brakes	138
Wheels and tyres	138
Electrics	139
Frame	141
Dimensions	141
Weights	142

Troubleshooting chart

Engine does not start at all or is difficult to start.

Possible cause	Remedy
Kill switch activated.	Kill switch in operating position (run).
Side stand extended and gear engaged.	Retract the side stand (➡ 68).
Gear engaged and clutch not disengaged	Select neutral or pull clutch lever (➡ 68).
Clutch pulled when ignition was OFF	Switch on the ignition, then pull the clutch lever.
No fuel in tank.	Refuelling (➡ 73)
Battery not adequately charged.	Charging battery when connected (➡ 118)

Threaded fasteners

Front wheel	Value	Valid
Front brake caliper to wheel carrier		
M8 x 32 - 10.9	30 Nm	
Clamping screw for quick-release axle in wheel carrier		
M8 x 30	19 Nm	
Quick-release axle in threaded bush		
M24 x 1.5	50 Nm	
Rear wheel	Value	Valid
Rear wheel to wheel flange		
M10 x 40 x 1.25	Tighten in diagonally opposite sequence	
	60 Nm	
Silencer to rear footrest, right		
M8 x 30	22 Nm	

Rear wheel	Value	Valid
Silencer to manifold		
M8 x 60 - 10.9	35 Nm	
Mirrors	Value	Valid
Mirror to clamping piece		
M10 x 1.25, left-hand thread	22 Nm	
Clamping piece to clamping block		
M10	25 Nm	

Engine

Engine, type	Transversely mounted, four-cylinder four-stroke in-line engine tilted 55° forward, with four valves per cylinder, two overhead camshafts with cam followers; liquid cooled, with electronic fuel injection, integrated six-speed cassette gearbox, dry-sump lubrication.
Effective displacement	1157 cm ³
Cylinder bore	79 mm
Piston stroke	59 mm
Compression ratio	13:1
Nominal output	120 kW, Over: 10250 min ⁻¹
with OE Reduced power output, 79 kW:	79 kW, Over: 8750 min ⁻¹
Max. torque	127 Nm, Over: 8250 min ⁻¹
with OE Reduced power output, 79 kW:	103 Nm, Over: 4500 min ⁻¹
Maximum permissible engine speed	11000 min ⁻¹
Idle speed	1150±50 min ⁻¹

Fuel	
Recommended fuel grade	98 ROZ/RON, Premium plus unleaded 95 ROZ/RON, Premium unleaded (fuel grade, usable with power- and consumption-related restrictions)
Fuel capacity, usable	19 l
Fuel capacity, reserve approx.	4 l
Engine oil	
Engine oil capacity, total	3.5 l, With filter change 0.5 l, Difference between MIN / MAX marks
Lubricant	Castrol GPS 10W-40 (SAE 10W40; API SG; JASO MA)
Oil grades	Mineral oils of API classification SF through SH. BMW Motorrad recommends not using oil additives, because they can have a detrimental effect on clutch operation. Please do not hesitate to contact your authorised BMW Motorrad dealer if you have any questions relating the choice of a suitable engine oil for your motorcycle.

Permissible viscosity classes

SAE 10 W-40	≥ -20 °C, Operation at low temperatures
SAE 15 W-40	≥ -10 °C

Performance figures

Top speed	>200 km/h
-----------	-----------

Clutch

Clutch type	Multiplate clutch running in oil bath
-------------	---------------------------------------

Transmission

Gearbox type	Claw-shift 6-speed cassette gearbox, integrated into engine block
--------------	---

Gear ratios

Gearbox transmission ratios	<p>1.559 (92:59 teeth), Primary transmission ratio</p> <p>2.294 (39:17 teeth), 1st gear</p> <p>1.789 (34:19 teeth), 2nd gear</p> <p>1.458 (35:24 teeth), 3rd gear</p> <p>1.240 (31:25 teeth), 4th gear</p> <p>1.094 (35:32 teeth), 5th gear</p> <p>0.971 (33:34 teeth), 6th gear</p> <p>1.045 (23:22 teeth), Angular drive</p>
-----------------------------	--

Rear-wheel drive

Final drive, type	Shaft drive with bevel gears
Final drive gear ratio	2.91 : 1

Running gear

Front suspension	Double leading link
Front-suspension spring travel	125 mm, At wheel
Rear suspension type	Central spring strut pivoted to lever system with coil spring and single-tube gas-filled shock absorber. Spring preload steplessly hydraulically adjustable, rebound stage damping steplessly adjustable.
with OE Electronic Suspension Adjustment (ESA):	Central spring strut pivoted to lever system with coil spring and single-tube gas-filled shock absorber. Spring basic setting three-way adjustable, compression and rebound stages each three-way adjustable
Rear-suspension spring travel	135 mm, At wheel

Brakes

Front brakes, type	Hydraulically operated twin disc brake with 4-piston fixed calipers and floating brake discs
Brake-pad material, front	Sintered metal
Rear brakes, type	Hydraulically operated disc brake with 2-piston floating caliper and fixed disc
Brake-pad material, rear	Organic material

Wheels and tyres

Front wheel, type	Cast aluminium, MT H2
Front wheel rim size	3.50" x 17"
Front wheel, tyre designation	120/70 ZR17
Rear wheel type	Cast aluminium, MT H2
Rear wheel rim size	5.50" x 17"
with OE Sports wheel:	6.00" x 17"
Rear wheel, tyre designation	180/55 ZR17
with OE Sports wheel:	190/50 ZR17

Tyre pressures

Tyre pressure, front	2.5 bar, One-up, tyre cold 2.5 bar, Two-up and/or with luggage, tyre cold
Tyre pressure, rear	2.9 bar, One-up, tyre cold 2.9 bar, Two-up and/or with luggage, tyre cold

Electrics

Rating of on-board socket	5 A
Fuses	All circuits are electronically protected, so plug-in fuses are no longer necessary. If an electronic fuse trips and de-energises a circuit, the circuit is active as soon as the ignition is switched on after the fault has been rectified.

Type

Battery type	AGM (Absorptive Glass Mat) battery
--------------	------------------------------------

Technical data

Battery rated voltage	12 V
Battery rated capacity	14 Ah

Technical data

Spark plug manufacturer and designation	NGK KR9CI
Spark plug electrode gap	0.8 mm, When new

Lighting

High-beam headlight bulb	H7 / 12 V / 55 W
Low-beam headlight bulb	H7 / 12 V / 55 W
Parking-light bulb	W5W / 12 V / 5 W
Bulb of tail light/brake light	P21W / 12 V / 21 W
Front flashing turn indicator bulbs	R10W / 12 V / 10 W
with OE White turn indicators:	RY10W / 12 V / 10 W
Rear flashing turn indicator bulbs	R10W / 12 V / 10 W
with OE White turn indicators:	RY10W / 12 V / 10 W

Frame

Frame type	Light alloy weldment with bolt-on tubular steel rear frame
Type plate location	Frame cross-tube, rear
VIN location	Frame side section, front right

Dimensions

Length of motorcycle	2288 mm
Height of motorcycle	1180 mm, at unladen weight, measured across mirrors
Width of motorcycle	856 mm, Across mirrors
Front-seat height	820 mm, At unladen weight
with OE Double seat, low:	790 mm, At unladen weight

Weights

Unladen weight	241 kg, DIN unladen weight, ready for road 90 % load of fuel, without optional extras
Permissible gross weight	450 kg
Maximum payload	209 kg

Service

BMW Motorrad service	144
BMW Motorrad service quality	144
BMW Motorrad Service Card: on-the-spot breakdown assistance	145
BMW Motorrad service network	145
Maintenance work	145
Maintenance schedules	146
Confirmation of maintenance work	147
Confirmation of service	152

BMW Motorrad service

Advanced technology requires specially adapted methods of maintenance and repair.



If maintenance and repair work is performed inexpertly, it could result in consequential damage and thus constitute a safety risk.

BMW Motorrad recommends you to have all the associated work on your motorcycle carried out by a specialist workshop, preferably an authorised BMW Motorrad dealer. ◀

Your authorised BMW Motorrad dealer can provide information on the specified Service, Inspection and Annual Inspection work needed. Have all maintenance and repair work carried out

confirmed in the "Service" chapter in this manual. Authorised BMW Motorrad dealers are supplied with the latest technical information and have the necessary technical know-how. BMW Motorrad recommends that you contact your authorised BMW Motorrad dealer if you have questions regarding your motorcycle.

BMW Motorrad service quality

Along with its reputation for engineering quality and high reliability, BMW Motorrad is a byword for excellent quality of service.

To ensure that your BMW is always in optimum condition, we recommend that you have the maintenance work required for your motorcycle carried out regularly, prefer-

ably by your authorised BMW Motorrad dealer. Evidence of regular maintenance is essential for generous treatment of goodwill claims.

Certain signs of wear, moreover, may otherwise not be noticed until it is too late to put them right at moderate cost. Your authorised BMW Motorrad dealer's mechanics know every detail of your motorcycle and can take remedial action if necessary before minor faults develop into serious problems. By having the necessary repairs done properly and in good time, you save time and money in the long run.

BMW Motorrad Service Card: on-the-spot breakdown assistance

In the event of a breakdown, the BMW Motorrad Service Card issued with each new BMW motorcycle enables you to access an extensive range of services such as breakdown assistance, motorcycle transportation etc. (details can differ from country to country). In the event of a breakdown, contact BMW Motorrad's Mobile Service. The specialists will provide the necessary advice and assistance.

You will find important country-specific contact addresses and the after-sales service organisation phone numbers in the "Service Kontakt / Service Contact"

brochures, along with information on Mobile Service and the dealership network.

BMW Motorrad service network

Our extensive after-sales service network is in place to look after you and your motorcycle in more than 100 countries. In Germany alone, you have the best possible access to approximately 200 authorised BMW Motorrad dealers.

All information concerning the international dealership network can be found in the brochures entitled "Service Contact Europe" and "Service Contact Africa, America, Asia, Australia, Oceania".

Maintenance work Intervals

Some maintenance tasks have to be performed after a certain time, others depend on the distance covered by the motorcycle.

BMW Running-in Check

The BMW running-in check has to be performed when the motorcycle has covered between 500 km and 1,200 km

BMW Annual Inspection

Some maintenance work has to be carried out at least once a year. Other tasks depend on the distance the motorcycle has covered.

BMW Service

After the first 10,000 km and every additional 20,000 km (30,000 km, 50,000 km, 70,000 km, etc.) if this distance is covered within a year.

BMW Inspection

After the first 20,000 km and every additional 20,000 km (40,000 km, 60,000 km, 80,000 km, etc.) if this distance is covered within a year.

Maintenance schedules

The maintenance schedule for your motorcycle depends on the equipment fitted, and on the motorcycle's age and the distance it has covered. Your authorised BMW Motorrad dealer will be happy to supply

a copy of the current maintenance schedule for your motorcycle on request.

Confirmation of maintenance work

BMW Pre-delivery Check

Carried out in accordance with manufacturer's instructions

Date, stamp, signature

BMW Running-in Check

Carried out in accordance with manufacturer's instructions

Odometer reading _____

Brake fluid, new

Date, stamp, signature

BMW Service

- BMW Annual Inspection
- BMW Service
- BMW Inspection

Carried out in accordance with manufacturer's instructions

Odometer reading_____

- Brake fluid, new

Date, stamp, signature

BMW Service

- BMW Annual Inspection
- BMW Service
- BMW Inspection

Carried out in accordance with manufacturer's instructions

Odometer reading_____

- Brake fluid, new

Date, stamp, signature

BMW Service

- BMW Annual Inspection
- BMW Service
- BMW Inspection

Carried out in accordance with manufacturer's instructions

Odometer reading_____

- Brake fluid, new

Date, stamp, signature

BMW Service

- BMW Annual Inspection
- BMW Service
- BMW Inspection

Carried out in accordance with manufacturer's instructions

Odometer reading_____

- Brake fluid, new

Date, stamp, signature

BMW Service

- BMW Annual Inspection
- BMW Service
- BMW Inspection

Carried out in accordance with manufacturer's instructions

Odometer reading_____

- Brake fluid, new

Date, stamp, signature

BMW Service

- BMW Annual Inspection
- BMW Service
- BMW Inspection

Carried out in accordance with manufacturer's instructions

Odometer reading_____

- Brake fluid, new

Date, stamp, signature

BMW Service

- BMW Annual Inspection
- BMW Service
- BMW Inspection

Carried out in accordance with manufacturer's instructions

Odometer reading_____

- Brake fluid, new

Date, stamp, signature

BMW Service

- BMW Annual Inspection
- BMW Service
- BMW Inspection

Carried out in accordance with manufacturer's instructions

Odometer reading_____

- Brake fluid, new

Date, stamp, signature

BMW Service

- BMW Annual Inspection
- BMW Service
- BMW Inspection

Carried out in accordance with manufacturer's instructions

Odometer reading_____

- Brake fluid, new

Date, stamp, signature

BMW Service

- BMW Annual Inspection
- BMW Service
- BMW Inspection

Carried out in accordance with manufacturer's instructions

Odometer reading_____

- Brake fluid, new

Date, stamp, signature

BMW Service

- BMW Annual Inspection
- BMW Service
- BMW Inspection

Carried out in accordance with manufacturer's instructions

Odometer reading_____

- Brake fluid, new

Date, stamp, signature

BMW Service

- BMW Annual Inspection
- BMW Service
- BMW Inspection

Carried out in accordance with manufacturer's instructions

Odometer reading_____

- Brake fluid, new

Date, stamp, signature

Item	Odometer reading	Date

- A**
 - Abbreviations and symbols, 6
 - Anti-theft alarm, 18
- B**
 - Battery
 - Battery compartment, 13
 - Charging battery when connected, 118
 - Charging battery when disconnected, 119
 - Installation, 119, 120
 - Removal, 119, 120
 - Technical data, 139
 - Warning, battery charge current, 28
 - Brake fluid
 - Checking level, front, 94
 - Checking level, rear, 95
 - Brake lever
 - Adjusting the handbrake lever, 51
 - Brake pads
 - Checking front, 92
 - Checking rear, 93
 - Brakes
 - Fluid reservoir, 13
 - Fluid reservoir, rear, 13
 - Front fluid reservoir, 13
 - Technical data, 138
 - Bulbs
 - General instructions, 108
 - Replacing brake-light bulb, 113
 - Replacing front turn indicator bulbs, 114
 - Replacing high-beam headlight bulb, 109
 - Replacing low-beam headlight bulb, 109
 - Replacing parking-light bulb, 111
 - Replacing rear light bulb, 113
 - Replacing rear turn indicator bulbs, 114
 - Technical data, 140
 - Warning, bulb failure, 29
- C**
 - Case
 - Adapting, 86
 - Adjusting, 84
 - Closing, 84
 - Installing, 86
 - Opening, 84
 - Removing, 85
 - Checklist, 68
 - Clock, 22
 - Adjusting, 44
 - Clutch
 - Adjusting the clutch lever, 51
 - Checking operation, 96
 - Fluid reservoir, 11
 - Technical data, 135
 - Confirmation of maintenance work, 147
- D**
 - Dimensions
 - Technical data, 141

E

- Electrics
 - Technical data, 139
- Emergency off switch (kill switch), 17, 50
- Engine
 - Starting, 68
 - Technical data, 133
 - Temperature gauge, 22, 23
 - Warning, engine electronics, 27
- Engine oil
 - Checking level, 89
 - Draining, 91
 - Filler neck, 15
 - Indicator for engine oil level, 13
 - Technical data, 134
 - Topping up, 90
 - Warning, engine oil level, 28
 - Warning, engine oil pressure, 27

ESA, 61

- Adjust suspension damping, 61
- Adjusting spring preload, 62
- Calling up settings, 61

EWS

- Warning, 26

F

- Final drive
 - Technical data, 136
- Frame
 - Technical data, 141
- Front-wheel stand
 - Installing, 105
- Fuel
 - Filler neck, 13
 - Quantity reading, 22
 - Refuelling, 73
 - Technical data, 134
 - Warning, fuel down to reserve, 26
- Fuses, 139

G

- Gear indicator, 22
- Grip heating, 17, 50

H

- Handlebar fittings
 - General view, left side, 16
 - General view, right side, 17
- Hazard warning flashers, 16, 17
 - Switching off, 43
 - Switching on, 42
- Headlight
 - Beam throw, 53
 - High-beam headlight, 19
 - Low-beam headlight, 19
 - Side light, 19
- Headlight flasher, 16
- Helmet holder, 15, 57
- High-beam headlight, 16
- Horn, 16

I

- Ignition
 - Switching off, 40
 - Switching on, 40

Immobiliser
Warning, 26

Instrument cluster
Overview, 18
Sensor for lighting, 18

J
Jump start, 116

K
Keys, 40

L
Laying up, 126

Lights
Low-beam headlight, 52
Side light, 52
Switching off parking
lights, 53
Switching on high-beam
headlight, 52
Switching on parking
lights, 53

M
Maintenance
General instructions, 88
Intervals, 145

Mirrors
Adjusting, 58

Multifunction display, 18, 22

O
Odometer and tripmeters, 22
Operation, 43
Pushbutton, 16
Resetting tripmeter, 44
Selecting readings, 43

On-board computer
Ambient temperature, 47
Average consumption, 48
Average speed, 47
Oil level, 49
Pushbutton, 16
Range, 48
Reset the average con-
sumption, 48

Reset the average
speed, 47
Select readings, 46

P
Power socket, 11
Pre-ride check, 69

R
Rear-wheel stand
Installing, 107

Refuelling, 73

Reserve
Warning, 26

Residual range, 44

Restoring to use, 127

Rev. counter, 18

Running gear
Technical data, 137

S
Seat
 Installation, 56
 Lock, 11
 Removal, 55
Service, 144
Service Card, 145
Side stand
 Starting the engine, 68
Spark plugs, 140
Speedometer, 18
Spring preload, rear
 Adjusting, 11, 59
Starter, 17
Steering lock
 Locking, 41
Suspension damping, rear
 Adjusting, 11, 60

T
Technical data
 Battery, 139
 Brakes, 138
 Bulbs, 140
 Clutch, 135
 Dimensions, 141
 Electrics, 139
 Engine, 133
 Engine oil, 134
 Frame, 141
 Fuel, 134
 Rear-wheel drive, 136
 Running gear, 137
 Spark plugs, 140
 Transmission, 135
 Weights, 142
 Wheels and tyres, 138
Telltale lights, 18
Toolkit, 15
 Service kit, 88
 Standard kit, 88
Torques, 131
Transmission
 Starting the engine, 68
 Technical data, 135
Troubleshooting chart, 130
Turn indicators
 Left, 16, 54
 Right, 17, 54
 Switching off, 17, 55

Tyre pressure control
 (ReifenDruck-Control)
 Label on wheel rim, 98
 Operation, 46
 Reading, 22
Tyres
 Checking tread depth, 97
 Checking tyre pressures, 62
 Recommended tyres, 97
 Technical data, 138

V
Vehicle
 General view, left side, 11
 General view, right side, 13
 Laying up, 126
 Restoring to use, 127
Vehicle identification number, 13

W
Warning lights, 18
Warnings, 22
 Mode of presentation, 23
Warnings, overview, 24, 32, 36

Weights

Technical data, 142

Wheels

Installing front wheel, 100

Installing rear wheel, 103

Removing front wheel, 98

Removing rear wheel, 102

Technical data, 138

Details described or illustrated in this booklet may differ from the motorcycle's actual specification as purchased, the accessories fitted or the national-market specification. No claims will be entertained as a result of such discrepancies.

Dimensions, weights, fuel consumption and performance data are quoted to the customary tolerances.

The right to modify designs, equipment and accessories is reserved.

Errors and omissions excepted.

© 2006 BMW Motorrad

Not to be reproduced either wholly or in part without written permission from BMW

Motorrad, After Sales.

Printed in Germany.

The most important data for a filling-station stop can be found in the following chart:

Fuel	
Recommended fuel grade	98 ROZ/RON, Premium plus unleaded 95 ROZ/RON, Premium unleaded (fuel grade, usable with power- and consumption-related restrictions)
Fuel capacity, usable	19 l
Fuel capacity, reserve approx.	4 l
Tyre pressures	
Tyre pressure, front	2.5 bar, One-up, tyre cold 2.5 bar, Two-up and/or with luggage, tyre cold
Tyre pressure, rear	2.9 bar, One-up, tyre cold 2.9 bar, Two-up and/or with luggage, tyre cold

BMW recommends



Order No. 01 41 7 706 701
08.2006, 1st edition

